



**Dear VIZIO Customer,**

Congratulations on your new VIZIO P50 High Definition Plasma Television purchase. Thank you for your support. For maximum benefit of your set, please read these instructions before making any adjustments, and retain them for future reference. We hope you will experience many years of enjoyment from your new VIZIO P50 High Definition Television.

**For assistance**, please call 714-668-0588 or e-mail us at [techsupport@vinc.com](mailto:techsupport@vinc.com).

To purchase or inquire about accessories and installation services for your VIZIO Plasma TV, please visit our website at [www.vizioce.com](http://www.vizioce.com) or call toll free at **888-VIZIOCE (888-849-4623)**.

We recommend you register your VIZIO P50HDTV either at our website [www.vizioce.com](http://www.vizioce.com) or fill in your registration card and mail it in. For peace of mind and to protect your investment beyond the standard warranty, VIZIO offers on-site extended warranty service plans. These plans give additional coverage during the standard warranty period. Visit our website or call us to purchase a plan.

Write down the serial number located on the back of your P50.

A H P \_\_\_\_\_

Purchase Date \_\_\_\_\_

*VIZIO is a registered trademark of V, Inc.*

**SRS** (●) TruSurround XT, SRS and (●) symbol are trademarks of SRS Labs, Inc.

**TruSurround XT** TruSurround XT technology is incorporated under license from SRS Labs, Inc.

HDMI logo and "High Definition Multimedia Interface" are registered trademarks of HDMI Licensing LLC.

"DCDi by Faroudja" is a registered trademark of Genesis Microchip Inc.



## THIS PRODUCT HAS BEEN DESIGNED AND TESTED FOR COMPLIANCE WITH REGULATORY SAFETY CERTIFICATIONS

This product is designed and manufactured to operate within defined design limits, and misuse may result in electric shock or fire. To prevent the product from being damaged, the following rules should be observed for the installation, use and maintenance of the product. Read the following safety instructions before operating the display. Keep these instructions in a safe place for future reference.

- To avoid the risk of electric shock or component damage, switch off the power before connecting other components to the P50 Plasma HDTV.
- Unplug the power cord before cleaning the P50 Plasma HDTV. A damp cloth is sufficient for cleaning the P50 Plasma HDTV. Do not use a liquid or a spray cleaner for cleaning the product. Do not use abrasive cleaners.
- Always use the accessories recommended by the manufacturer to insure compatibility.
- When moving the P50 Plasma HDTV from an area of low temperature to an area of high temperature, condensation may form on the housing. Do not turn on the P50 Plasma HDTV immediately after this to avoid causing fire, electric shock or component damage.
- Do not place the P50 Plasma HDTV on an unstable cart, stand, or table. If the P50 Plasma HDTV falls, it can injure a person and cause serious damage to the appliance. Use only a cart or stand recommended by the manufacturer or sold with the P50 Plasma HDTV.
- A distance of at least 3 feet should be maintained between the P50 Plasma HDTV and any heat source, i.e. radiator, heater, oven, amplifier etc. Do not install the product close to smoke. Operating the product close to smoke or moisture may cause fire or electric shock.
- Slots and openings in the back and bottom of the cabinet are provided for ventilation. To ensure reliable operation of the P50 Plasma HDTV and to protect it from overheating, be sure these openings are not blocked or covered. Do not place the P50 Plasma HDTV in a bookcase or cabinet unless proper ventilation is provided.
- Never push any object into the slot on the P50 Plasma HDTV cabinet. Do not place any objects on the top of the product. It could short circuit parts causing a fire or electric shock. Never spill liquids on the P50 Plasma HDTV.
- The P50 Plasma HDTV should be operated only from the type of power source indicated on the label. If you are not sure of the type of power supplied to your home, consult your dealer or local power company.
- The power cable must be replaced when using different voltage from that specified in the User Manual. For more information, contact your dealer.
- The P50 Plasma HDTV is equipped with a three-pronged grounded plug, a plug with a third (grounding) pin. This plug will fit only into a grounded power outlet as a safety feature. If your outlet does not accommodate the three-wire plug, have an electrician install the correct outlet, or use an adapter to ground the appliance safely. Do not defeat the safety purpose of the grounded plug.
- Do not overload power strips and extension cords. Overloading can result in fire or electric shock.
- The wall socket shall be installed near the equipment and shall be easily accessible.
- Only the marked power source can be used for the product. Any power source other than the specified one may cause fire or electric shock.
- Do not touch the power cord during lightning. To avoid electric shock, avoid handling the power cord during electrical storms.
- Unplug the unit during a lightening storm or when it will not be used for long period of time. This will protect the P50 Plasma HDTV from damage due to power surges.
- Do not attempt to repair or service the product yourself. Opening or removing the back cover may expose you to high voltages, the risk of electric shock, and other hazards. If repair is required, please contact your dealer and refer all servicing to qualified service personnel.
- Keep the product away from moisture. Do not expose this appliance to rain or moisture. If water penetrates into the product, unplug the power cord and contact your dealer. Continuous use in this case may result in fire or electric shock.
- Do not use the product if any abnormality occurs. If any smoke or odor becomes apparent, unplug the power cord and contact your dealer immediately. Do not try to repair the product yourself.
- Avoid using dropped or damaged appliances. If the product is dropped and the housing is damaged, the internal components may function abnormally. Unplug the power cord immediately and contact your dealer for repair. Continued use of the product may cause fire or electric shock.
- Do not install the product in an area with heavy dust or high humidity. Operating the product in environments with heavy dust or high humidity may cause fire or electric shock.
- Follow instructions for moving the product. Ensure that the power connector and any other cables are unplugged before moving the product.
- Hold the power connector when removing the power cable. Pulling the power cable itself may damage the wires inside the cable and cause fire or electric shock. When the product will not be used for an extended period of time, unplug the power connector.
- To avoid risk of electric shock, do not touch the connector with wet hands.
- Insert batteries in accordance with instructions. Incorrect polarities may cause damage and leakage of the batteries, operator injury and contamination the remote controller.
- If any of the following occurs please contact the dealer:
  - The power connector fails or frays.
  - Liquid sprays or any object drops into the P50 Plasma HDTV.
  - The Display is exposed to rain or other moisture.
  - The Display is dropped or damaged in any way.
  - The performance of the Display changes substantially.
- Operating environment. Temperature: 40°F ~ 95°F, Humidity: 10% ~ 90% non-condensing, Altitude: 0 ~ 6500ft (0 ~ 2000m)



## Television Antenna Connection Protection

### External Television Antenna Grounding

If an outside antenna/satellite dish or cable system is to be connected to the TV, make sure that the antenna or cable system is electrically grounded to provide some protection against voltage surges and static charges.

Article 810 of the National Electrical Code, ANSI/NFPA 70, provides information with regard to proper grounding of the mast and supporting structure, grounding of the lead-in wire to an antenna discharge unit, size of the grounding conductors, location of antenna discharge unit, connection to grounding electrodes, and requirements of the grounding electrode.

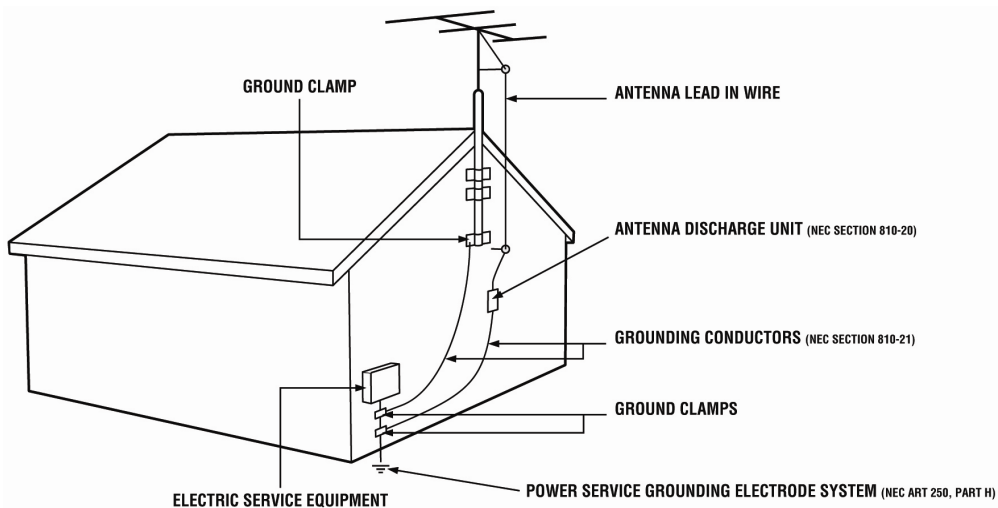

### Lightning Protection

For added protection of the TV during a lightning storm or when it is left unattended or unused for long periods of time, unplug the TV from the wall outlet and disconnect the antenna or cable system.

### Power Lines

Do not locate the antenna near overhead light or power circuits, or where it could fall into such power lines or circuits.



## Opening the Package

Your VIZIO P50HDTV and its accompanying accessories are carefully packed in a cardboard carton that has been designed to protect it from transportation damage. Now you have opened the carton, check that the P50HDTV is in good condition and that all of the accessories are included.

The P50HDTV weighs approximately 123lb (55.7kg) and about 48.8" wide x 34.2" tall, we strongly advise that you have at least 2 people to unpack and install the HDTV.

The glass surface can easily be scratched or broken, so please handle the product gently and never place the HDTV with the glass facing downwards on a surface without protective padding.

**IMPORTANT:** Save the carton and packing material for future shipping.

## Package Contents

VIZIO P50HDTV

VIZIO Remote Control by Universal Electronics

AV Cable (Yellow, Red and White Connectors)

Power Cord

VIZIO Bezel and Screen Cleaning Cloth

This User Manual

Quick Setup Guide

Registration Card

VIP Services Brochure



## Additional Certified Accessories for the VIZIO P50HDTV are sold separately

Wall Mounts

High Definition Cables

Extra or replacement Remote

VIZIO also offers Installation Services and Extended Warranty Services for your VIZIO P50HDTV

To purchase or inquire about additional accessories and services for your VIZIO product, visit our web site at [www.vizioce.com](http://www.vizioce.com) or call us toll free at 888-VIZIOCE (888-849-4623)

## Installation Preparation

Please read this user manual carefully before installing your VIZIO HDTV.

The power consumption of the TV is about 500W, please use the power cord designated for TV. When an extension cord is required, use one with the correct power rating. The cord must be grounded and the grounding feature must not be defeated.

The TV should be installed on a flat surface to avoid tipping. For proper ventilation, you must allow space between the back of the TV and the wall. If you would like to mount your TV on the wall, please see below 'Preparing Your Plasma TV for Wall Mounting' for additional information. Avoid installing the TV in places with high humidity, dust or smoke so as not to shorten the service life of the electronic components. Install the TV in landscape orientation; any 90° clockwise or counter-clockwise installation may induce poor ventilation and excessive component damage.

VIZIO offers professional installation services. Please contact VIZIO for more information on these services at 888-VIZIOCE (888-849-4623) or [www.vizioce.com](http://www.vizioce.com).



## Preparing Your Plasma TV for Wall Mounting

The VIZIO P50HDTV can either be kept on the stand base or mounted on the wall for viewing. If you choose to mount the P50HDTV on the wall, please follow the instructions below for removing the stand base.

### To remove the stand base

1. Unplug all of the cables and cords from your P50HDTV.
2. Place the P50HDTV face down on a soft and flat surface (blanket, foam, cloth, etc) to prevent any damage to the TV.
3. Remove the six (6) screws on each side of the back panel of the P50HDTV located near the bottom so that the stand base can be removed (see Figure A).
4. Gently pull the stand away from the P50HDTV by grasping firmly on the base.

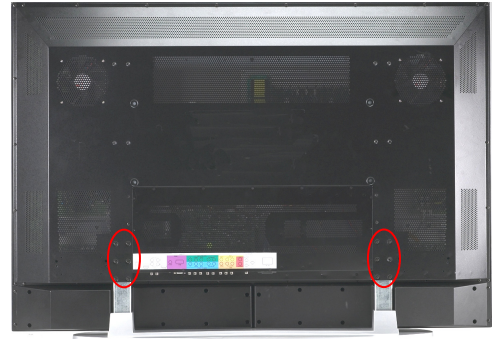

Figure A

5. Now, the P50HDTV can fit securely to a mount (sold separately) by utilizing the mounting holes in the center of the back panel of the TV (see Figure B). Please make sure to read the instructions of your specific mount to properly hang the P50HDTV.



Figure B

To find the perfect mount for the VIZIO P50HDTV, browse VIZIO's certified mount selection at [www.vizio.com](http://www.vizio.com) or call directly 888-VIZIOCE (888-849-4623).



# Table of Contents

- Chapter 1 Basic Controls and Connections ..... 9**
  - 1.1 Front Panel ..... 9
  - 1.2 Side Panel Controls ..... 9
  - 1.3 Rear Panel Connections ..... 10
  - 1.4 VIZIO Universal Remote Control ..... 12
    - 1.4.1 Insertion of Batteries in the Remote Control ..... 15
    - 1.4.2 Remote Control Range ..... 15
    - 1.4.3 VIZIO Universal Remote Control Precautions ..... 15
- Chapter 2 Connecting Equipment ..... 16**
  - 2.1 Which Video Connection Should I Use? ..... 16
  - 2.2 Connecting Your DVD Player ..... 17
    - 2.2.1 Using HDMI ..... 17
    - 2.2.2 Using Component Video ..... 19
    - 2.2.3 Using S-Video (AV) ..... 20
    - 2.2.4 Using Composite (AV) Video ..... 21
  - 2.3 Connecting Your HDTV Set-Top Box ..... 22
    - 2.3.1 Using HDMI ..... 22
    - 2.3.2 Using Component Video ..... 24
  - 2.4 Connecting Your VCR or Video Camera ..... 25
  - 2.5 Connecting Coaxial (RF) ..... 26
    - 2.5.1 Using Your Antenna or Digital Cable for DTV ..... 26
    - 2.5.2 Using Your Antenna or Cable for TV ..... 27
    - 2.5.3 Using the Antenna or Cable through your VCR ..... 27
  - 2.6 Connecting an external Receiver/Amp ..... 28
  - 2.7 Connecting a PC Computer ..... 29
- Chapter 3 Setting Up to Watch Television ..... 30**
  - 3.1 Basic Plasma TV Start Up ..... 30
  - 3.2 Watching a TV Program ..... 33
  - 3.3 Adjusting Basic Plasma TV Settings ..... 33
  - 3.4 DTV Tuner Setup ..... 34
    - 3.4.1 Parental Controls for DTV ..... 42
    - 3.4.2 DTV Channel Information ..... 44
    - 3.4.3 Program Information ..... 45
    - 3.4.4 Setting a Password ..... 46
  - 3.5 Using the On Screen Display (OSD) ..... 47
    - 3.5.1 OSD Menu Operations ..... 47
    - 3.5.2 Image Settings for Video Inputs ..... 48
    - 3.5.3 Advanced Image Settings for Video inputs ..... 49
    - 3.5.4 Image Settings (for PC) ..... 49
    - 3.5.5 Advanced Image Settings for PC ..... 50
    - 3.5.6 Display Settings ..... 50
    - 3.5.7 Audio Settings ..... 51
    - 3.5.8 Parental Controls ..... 51
    - 3.5.9 Setup ..... 52
    - 3.5.10 Understanding Viewing Features ..... 53
    - 3.5.11 Viewing Modes ..... 53
    - 3.5.12 Picture-In-Picture(PIP)/Picture-by-Picture(POP)Mode ..... 54
    - 3.5.13 Adjusting Basic PIP/POP Settings ..... 54
    - 3.5.14 Using the Parental Controls ..... 55
  - 3.6 Programming the VIZIO Universal Remote Control ..... 57
    - 3.6.1 Programming for VCR ..... 57
    - 3.6.2 Programming for Cable Set-Top Box ..... 57
    - 3.6.3 Programming for DVD Player ..... 58
    - 3.6.4 Searching for Component Codes ..... 58
  - 3.7 Using a Cable or Satellite Remote ..... 58
- Chapter 4 Maintenance and Troubleshooting ..... 59**
  - 4.1 Maintenance ..... 59
  - 4.2 Troubleshooting Guide ..... 59
  - 4.3 Telephone & Technical Support ..... 61



4.4 Compliance ..... 62

4.5 FCC Class B Radio Interference Statement ..... 62

**Chapter 5 Miscellaneous Information ..... 63**

5.1 Specifications ..... 63

5.2 Glossary – Standard Definitions ..... 64

5.3 Index ..... 65

5.4 Limited Product Warranty ..... 68

    5.4.1 VIZIO EXTENDED SERVICE WARRANTY ..... 68

5.5 Component Program Codes ..... 69





## Chapter 1 Basic Controls and Connections

### 1.1 Front Panel

**Power LED** – Lights green when powered on, yellow when powered off.

**Remote Control Sensor** – This is the window through which all of the remote control signals pass to the sensor. Point the remote control directly at this window for the best response to the remote signal.



### 1.2 Side Panel Controls

**Power** (  ) – Switch the P50HDTV on by pressing the button once. Press the button again to the P50HDTV off.

**Menu** – This button activates the On Screen Display (OSD). If a sub-menu is active, pressing this button will return to the previous menu level.

**Channel** ▲/▼ – Use these buttons to step up or down the TV channels. While the OSD is active, these buttons function as up and down controls in the OSD menus.

**Volume** ◀/▶ – Use these buttons to increase or decrease to the speaker volume. While the OSD is active, these buttons function as left and right controls in the OSD menus.

**Input (Enter)** – Repeated pressing of this buttons steps through the input sources in the following sequence: DTV, TV, RGB, AV1 (S-Video or video\*), AV2 (S-Video or video\*), Component 1, Component 2, HDMI 1, and HDMI 2. Once you have stepped through the entire sequence, you will return to the beginning.

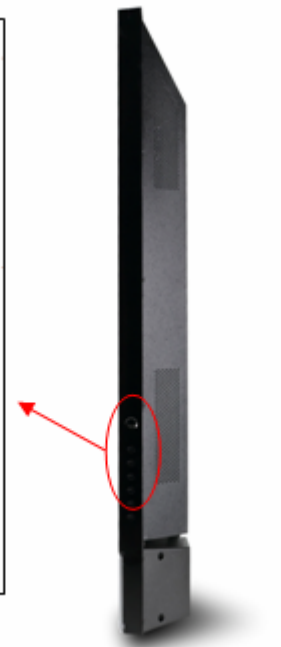

Additionally, when the OSD is active, this button confirms the menu function to be adjusted. When the OSD is not active, pressing this button will display the current input mode.

*\*S-Video has priority. If a signal is connected to AV1 S-Video by itself or signals are connected to AV1 S-Video and AV1 Video simultaneously, then S-Video will be the only choice for AV1. If a signal is connected to AV1 Video only, then Video will be the only choice for AV1. The same input priority scheme applies to AV2.*



## 1.3 Rear Panel Connections

### Right Portion



1. **SERVICE 2** – This custom communication port is for factory service only.
2. **DTV** – Connect to an antenna or digital cable for Digital TV.\*
3. **OPTICAL DIGITAL AUDIO OUT** – When the DTV input is selected for viewing, the digital audio associated with digital programming will be available on this SPDIF Optical connector for connection to your home theatre system. The gray color band on the rear of the TV indicates this connection.
4. **AC IN** – Plug-in the supplied AC Power Cord here.

\* For digital TV stations in your area visit [www.antennaweb.org](http://www.antennaweb.org).



Left Portion

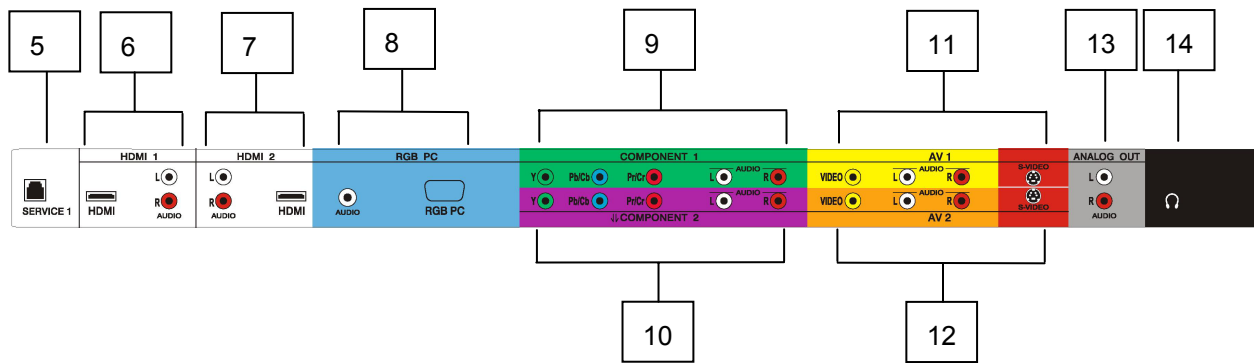

5. **SERVICE 1** – This custom communication port is for factory service only.
6. **HDMI 1** – Connect the primary source for digital video devices such as a DVD multimedia player or set top box through this all digital connector. The white color band on the rear of the TV indicates this connection. For users who want to connect to a DVI enabled device, use a DVI-HDMI cable and connect the Analog Audio output of the device to the L+R AUDIO here. Your VIZIO Certified HDMI and HDMI-DVI cables are available for purchase from [www.vizioce.com](http://www.vizioce.com) or by calling 888-VIZIOCE (888-849-4623).
7. **HDMI 2** – Connect the secondary source for digital video devices such as a DVD multimedia player or set top box through this all digital connector. The white color band on the rear of the TV indicates this connection. For users who want to connect to a DVI enabled device, use a DVI-HDMI cable and connect the Analog Audio output of the device to the L+R AUDIO here.
8. **RGB PC** – Connect the video and audio from a computer here. The blue color band on the rear of the TV indicates this connection.
9. **COMPONENT 1 (YPb/CbPr/Cr with Audio L/R)** – Connect the primary source for component video devices such as a DVD Player or set top box here. From left to right, use green for Y, blue for Pb (or Cb), red for Pr (or Cr), white for left audio and red for right audio inputs. The green color band on the rear of the TV indicates this connection.
10. **COMPONENT 2 (YPb/CbPr/Cr with Audio L/R)** – Connect the secondary source for component video devices such as a DVD Player or set top box here. From left to right, use green for Y, blue for Pb (or Cb), red for Pr (or Cr), white for left audio and red for right audio inputs. The purple color band on the rear of the TV indicates this connection.
11. **AV1 In** – Connect the primary source for composite video devices, such as a VCR or video game. Use the white and red connectors to connect the external audio from the same source. The yellow color band on the rear of the TV indicates this connection.
12. **AV2 In** – Connect the secondary source for composite video devices, such as a VCR or video game. Use the white and red connectors to connect the external audio from the same source. The orange color band on the rear of the TV indicates this connection.
13. **Analog Audio Out** – Connect the audio from the Plasma TV to an external device, such as a home theatre system, external amplifier or stereo. Speakers cannot be connected directly to here. The gray color band on the rear of the TV indicates this connection.
14. **Headphone Out** – Connect a headphone directly or use a wireless headphone system.



## 1.4 VIZIO Universal Remote Control

The VIZIO Universal Remote Control is a comprehensive remote that can be used to control up to four different components. The remote control button functions are explained on the following pages.

### VIZIO Remote Control Button Description

**SET** – This button starts all programming sequences.

**Remote LED** – Blinks when the remote operates.

**POWER** – Press this button to turn the TV on from the Standby mode. Press it again to return to the Standby mode.

**TV** – This button has been pre-programmed to select the codes to operate the P50HDTV.

**VCR** – This button selects a programmed VCR.

**CABLE** – This button selects a programmed cable TV set-top box or a satellite TV set-top box.

**DVD** – This button selects a programmed DVD player.

**Number Button Pad** – Use these buttons to select a channel or enter a password.

**INPUT** – This button allows the user to cycle through the inputs.

**-/ENTER** – This button works as a DASH button in the DTV mode. When selecting a digital channel directly use this button for the separation of main and sub-channels. For example, channel 28-2 would be selected by the button sequence 2 8 ENTER 2.

**CH (+ or -)** – These buttons change the channels up or down.

**LAST** – This button recalls the previously viewed channel.

**MUTE** – This button turns the sound on and off. **VOL (+ or -)** – These buttons turn the volume up or down.

**MENU** – This button is used to turn the On-Screen Display (OSD) menus on.

**INFO** – This button displays the image and system information display.

**GUIDE** – This button displays program information. *Note: this button is only functional for DTV.*

**EXIT** – This button exits the On-Screen Display (OSD) menus.

**Navigation Buttons** – These buttons navigate the On-Screen Display (OSD) menus.

**OK** – This button works to select your chosen option in On-Screen Display (OSD) menus.



**NOTE:** This is a programmable remote supporting up to 4 devices (see TV, VCR, CABLE, DVD buttons at the top of the remote). If the remote is not working with your VIZIO TV, press the TV button on the remote to set the functions back to TV.



**WIDE/Record** – This button cycles through the available screen formats. The options are Wide, Normal, Zoom, Panoramic. *Note:* in RGB/PC mode the options are 4:3 and 16:9. This button also functions as VCR Record when the component is activated with the remote control.

**SLEEP/Pause** – This button allows the user to select the sleep options by adjusting the timer in 30 minute increments up to 120 minutes. Additionally, this button pauses the CD, DVD or VCR when the component is activated with the remote control.

**MTS/Play** – This button will select the MTS options of Stereo, SAP or Mono in TV mode and alternate audio channels, where available, in DTV mode. Additionally, this button plays the CD, DVD or VCR when the component is activated with the remote control.

**CC/Stop** – Use this button will set the Closed Caption mode when viewing a DTV or TV channel. **Note: To set the default Closed Caption setting for all channels see Section 3.4, DTV Tuner Setup.** For DTV the options are CC1, CC2, CC3, CC4, Service1 or Service2. For TV and AV, the options are On or Off. Additionally, this button stops the CD, DVD or VCR when the component is activated with the remote control.

**TV/Previous Chapter** – Repeated pressing of this button switches between DTV and TV programming. *Note:* This button has been pre-programmed for the VIZIO P50HDTV. This button also functions as a DVD Previous Chapter when the DVD player is activated with the remote control.

**AV/Reverse** – Repeated pressing of this button with switch between AV1 and AV2 inputs. Additionally, this button rewinds the CD, DVD or VCR when the component is activated with the remote control.

**COMPONENT/Forward** – Repeated pressing of this button with switch between Component 1 and Component 2 inputs. Additionally, this button forwards the CD, DVD or VCR when the component is activated with the remote control.

**HDMI/ Next Chapter** – This button will select the HDMI input. Additionally, this button functions as a DVD Next Chapter when the component is activated with the remote control.

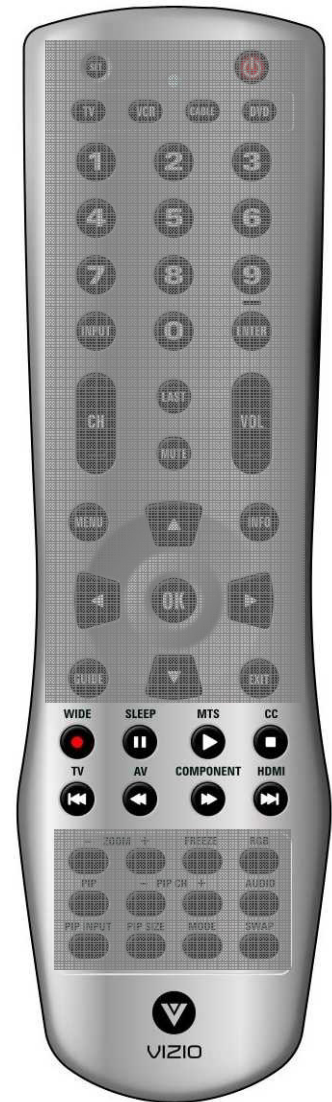

**ZOOM (- and +)** – Use these buttons to increase or decrease the size of the picture. Note that in the zoom mode parts of the picture will not be visible because they extend beyond the edges of the screen.

**FREEZE** – Press this button to “Freeze-Frame” the current screen. Press this button again to continue playing.

**RGB** – This button selects a connected RGB Analog component such as a PC.

**PIP** – Use this button to activate the Picture-In-Picture mode.

**PIP CH (- and +)** – These buttons are used to select the channels within the PIP screen when DTV/TV is the PIP input selected.

**AUDIO** – Press this button to switch the audio from the main screen to the sub-screen while in PIP or POP mode.

**PIP Input** – Press the button to choose the PIP input. Note: The TV must be in PIP/POP mode for this button to be functional. For additional information regarding the PIP/POP options, see 3.5.12 – Picture-In-Picture (PIP) Mode, page 54.

**PIP Size** – Press this button to select the size of the PIP screen from one of the following: small, medium or large.

**MODE** – This button is not functional for the VIZIO P50.

**SWAP** – Used to swap the inputs from the main screen and the sub-screen while in PIP/POP mode.



### 1.4.1 Insertion of Batteries in the Remote Control

Insert two AA batteries into the remote control. Make sure that you match the (+) and (-) symbols on the batteries with the (+) and (-) symbols inside the battery compartment. Re-attach the battery cover.

Precautionary Tips for Inserting the Batteries:

Only use the specified AA batteries.

Do not mix new and old batteries. This may result in cracking or leakage that may pose a fire risk or lead to personal injury.

Inserting the batteries incorrectly may also result in cracking or leakage that may pose a fire risk or lead to personal injury.

Dispose of the batteries in accordance with local laws and regulations.

Keep the batteries away from children and pets.



### 1.4.2 Remote Control Range

Point the remote control at the remote control sensor to transmit the commands.

Do not place any obstacles between the remote control and the receiver window.

The effective range of the remote control is approximately 30 feet (10 meters) from the front of the receiver window, 30° to the left and right, 20° up and down.

### 1.4.3 VIZIO Universal Remote Control Precautions

The remote control should be kept dry and away from heat sources. Avoid humidity.

If the TV responds erratically to the remote control or does not respond at all, check the batteries. If the batteries are low or exhausted, replace them with fresh batteries.

When not using the remote control for a long period of time, remove the batteries.

Do not take the batteries apart, heat them, or throw them into a fire.

Do not subject the remote control to undue physical stress, such as striking or dropping it.







Do not attempt to clean the remote control with a volatile solvent. Wipe it with a clean, damp cloth.

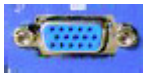

## Chapter 2 Connecting Equipment

### 2.1 Which Video Connection Should I Use?

The VIZIO P50HDTV has six different ways to connect your video equipment from a basic connection to the most advanced for digital displays.

Connection Quality (type)	Connector	Rear Panel Color Codes	Description
Best (digital)		White	HDMI (High-Definition Multimedia Interface) - It is the first and only industry-supported, uncompressed, all-digital audio/video interface. HDMI provides an interface between any audio/video source, such as a set-top box, DVD player, or A/V receiver and an audio and/or video monitor, such as a digital television (DTV), over a single cable.
Best (digital) ----- Good (analog)		Black	DTV Coaxial RF. When used for MPEG2 encoded bit streams from ATSC broadcast programming, this input takes advantage of the High Definition content. ----- TV Coaxial RF. This is the connection for standard NTSC TV using antenna or cable.
Best (analog)		Blue	RGB PC (VGA) – This video input has separate red, green and blue color components. The signal carries horizontal and vertical sync information on the green signal. This is most commonly used for PC input.
Better (analog)		Green and Purple	Component 1/2 - The video signal is separated into three signals, one containing the black-and-white information and the other two containing the color information. This enhancement over S-Video takes advantage of the superior picture provided by progressive scan DVD players and HDTV formats.
Good (analog)		Red	S-Video (AV1/AV2) - The video signal is separated into two signals, one containing the black-and-white information and the other containing the color information. Separating the color in this way avoids 'cross color' effects where closely spaced black and white lines are erroneously displayed in color. It also enables text to be displayed more sharply.
Good (analog)		Yellow and Orange	AV1/AV2 (Composite) - The complete video signal is carried through this single pin connector. This is the most commonly used video connection.

Note: For more info refer to the Quick Start Guide





## 2.2 Connecting Your DVD Player

You have several options for connecting your DVD player to your P50HDTV – HDMI, Component, S-Video and Composite (AV) inputs. Based on your home theater configuration, you can decide which option is the right one for you.

### 2.2.1 Using HDMI

DVD players that have a digital interface such as HDMI (High Definition Multimedia Interface) should be connected to the HDMI input of the VIZIO P50HDTV for optimal results.

Note: To maintain the display quality, use a VIZIO certified HDMI cable available up to 10 meters or less. See [www.VIZIO.com](http://www.VIZIO.com) or call 1-888-VIZIOCE (1-888-849-4623) for details.

### Connecting your DVD Player (Best):

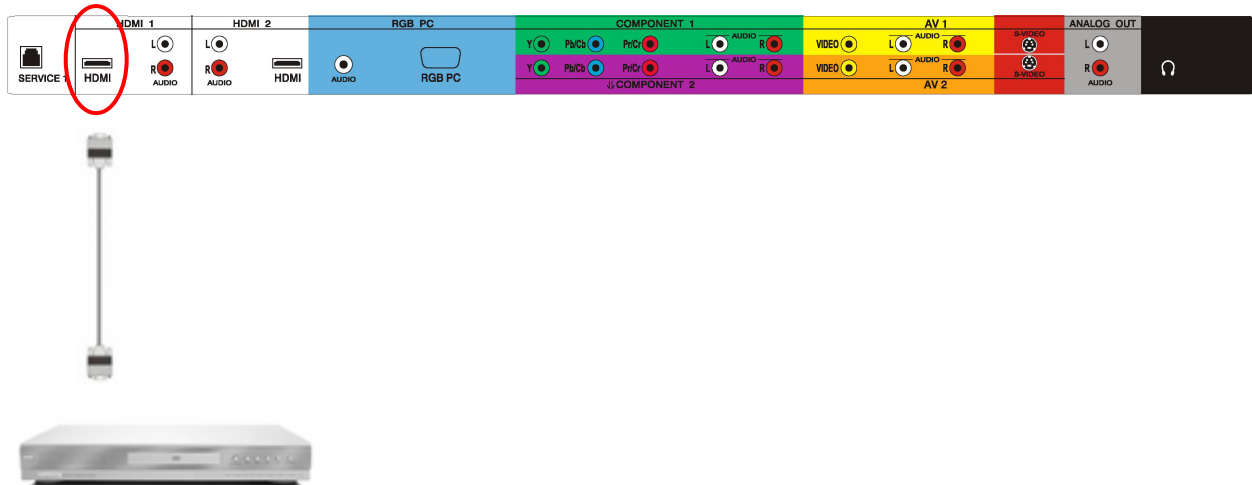

1. Turn off the power to the Plasma TV and DVD player.
2. Connect one end of a HDMI cable to the HDMI output of your DVD player and the other end to the HDMI 1 Input (white color area) at the rear of the Plasma TV.
3. Turn on the power to the Plasma TV and your DVD player.
4. Select HDMI 1 using the INPUT button on the remote or side of the Plasma TV, or directly by pressing the HDMI button on the Remote Control.

Note:

- a) If you are already using the HDMI 1 input for another component, or you do not want to use the HDMI 1 input for the DVD player, you can connect the DVD player to the HDMI 2 connection.
- b) Refer to your DVD player user manual for more information about the video output requirements of the product.



## For DVD Players with DVI:

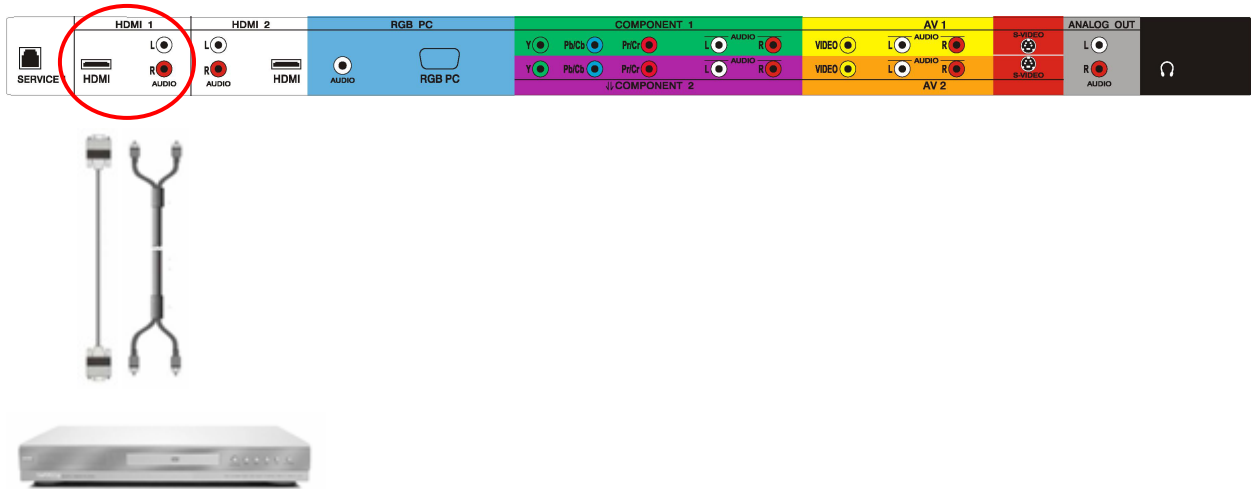

1. Turn off the power to the Plasma TV and DVD player.
2. Using a HDMI-DVI cable, connect the DVI end to your DVD player and the HDMI end to the HDMI 1 Input (white color area) at the rear of the Plasma TV.
3. Using an audio cable (white and red connectors), connect the cable to the audio output connectors associated with the DVI output on your DVD player and connect the other end to the audio connectors associated with the HDMI 1 input (white area) at the rear of the Plasma TV.
4. Turn on the power to the Plasma TV and your DVD player.
5. Select HDMI 1 using the INPUT button on the remote or side of the Plasma TV, or directly by pressing the HDMI button on the Remote Control.

### Note:

- b) If you are already using the HDMI 1 input for another component, or you do not want to use the HDMI 1 input for the DVD player, you can connect the DVD player to the HDMI 2 connection.
- c) Refer to your DVD player user manual for more information about the video output requirements of the product.



## 2.2.2 Using Component Video

### Connecting your DVD Player (Better):

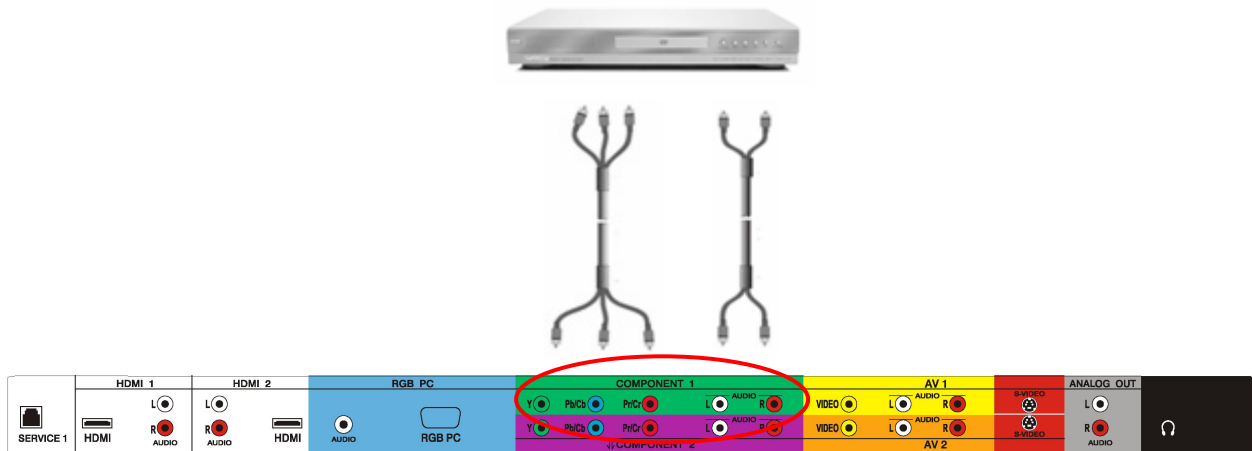

1. Turn off the power to the Plasma TV and DVD player.
2. Connect the Y (green color) connector on your DVD player to the corresponding Y (green color) connector in the Component 1 group (green color area - row of connectors nearest to you when viewing from the rear of the TV) at the rear of the Plasma TV.
3. Connect the Pb (blue color) connector on your DVD player to the corresponding Pb (blue color) connector in the Component 1 group (green color area - row of connectors nearest to you when viewing from the rear of the TV) at the rear of the Plasma TV.
4. Connect the Pr (red color) connector on your DVD player to the corresponding Pr (red color) connector in the Component 1 group (green color area - row of connectors nearest to you when viewing from the rear of the TV) at the rear of the Plasma TV.
5. Using an audio cable (white and red connectors), connect the cable to the audio output connectors associated with the Component output on your DVD player and connect the other end to the audio connectors associated with the Component 1 input (green color area) at the rear of the Plasma TV.
6. Turn on the power to the Plasma TV and DVD player.
7. Select Component 1 using the INPUT button on the remote or side of the Plasma TV, or directly by pressing the Component button on the Remote Control.

**Note:**

- a) If you are already using the Component 1 input for another component, or you do not want to use the Component 1 input for the DVD player, you can connect the DVD player to the Component 2 connections coded by the purple area.
- b) Refer to your DVD player user manual for more information about the video output requirements of the product.



## 2.2.3 Using S-Video (AV)

### Connecting your DVD Player (Good):



1. Turn off the power to the Plasma TV and DVD player.
2. Connect the S-Video jack on the rear of your DVD player to the S-Video jack in the AV1 group (red area) at the rear of the Plasma TV.
3. Using an audio cable (white and red connectors), connect the cable to the audio output connectors associated with the S-Video output on your DVD player and connect the other end to the audio connectors associated with the AV1 input (yellow area) at the rear of the Plasma TV.
4. Turn on the power to the Plasma TV and DVD player.
5. Select AV1 using the INPUT button on the remote or side of the Plasma TV, or directly by pressing the AV button on the Remote Control.

**Note:**

- a) If you are already using the AV1 input for another component, or you do not want to use the AV1 input for the DVD player, you can connect the DVD player to the AV2 connections coded by the red & orange areas.
- b) Refer to your DVD player user manual for more information about the video output requirements of the product.



## 2.2.4 Using Composite (AV) Video

### Connecting your DVD Player (Good) :

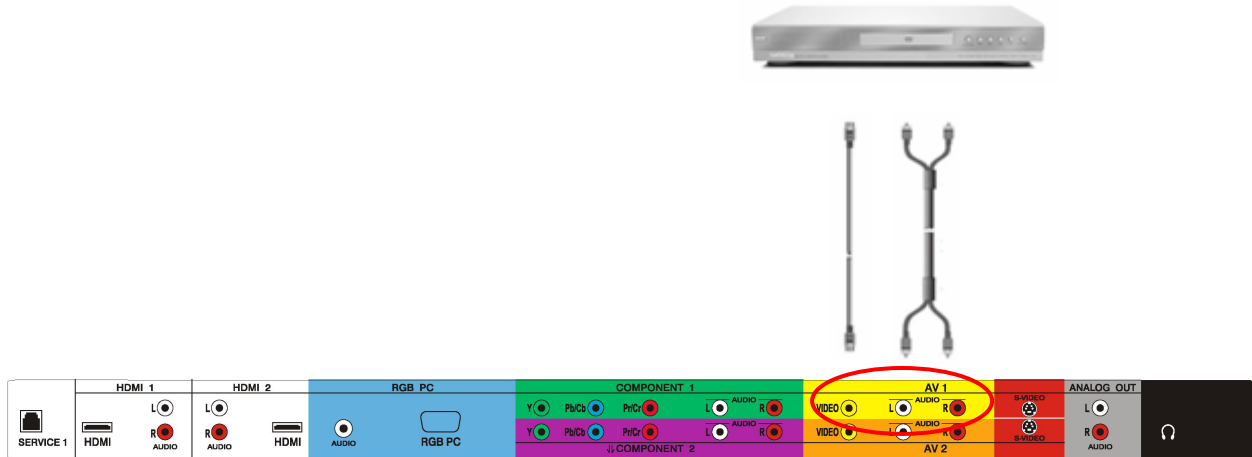

1. Turn off the power to the Plasma TV and DVD player.
2. Connect the Video (yellow color) connector on your DVD player to the Video (yellow color) connector in the AV1 group (yellow color area - row of connectors nearest to you when viewing from the rear of the TV) at the rear of the Plasma TV.
3. Connect the R (red color) and L (white color) audio connectors on your DVD player to the corresponding R (red color) and L (white color) audio input connectors in the AV1 group (yellow color area - row of connectors nearest to you when viewing from the rear of the TV) at the rear of the Plasma TV.
4. Turn on the power to the Plasma TV and DVD Player.
5. Select AV1 using the INPUT button on the remote or side of the Plasma TV, or directly by pressing the AV button on the Remote Control.

**Note:**

- a) If you are already using the AV1 input for another component, or you do not want to use the AV1 input for the DVD player, you can connect the DVD player to the AV2 connections coded by the orange area.
- b) Refer to your DVD player user manual for more information about the video output requirements of the product.



## 2.3 Connecting Your HDTV Set-Top Box

### 2.3.1 Using HDMI

HDTV Set-Top Boxes that have a HDMI digital interface should be connected to the HDMI input of the Plasma TV for optimal results.

Note: To maintain the display quality, use a VIZIO certified HDMI cable that is 10 meters or less. See [www.vizioce.com](http://www.vizioce.com) or call 1-888-VIZIOCE (1-888-849-4623) for details.

### Connecting your Set-Top Box (Best):

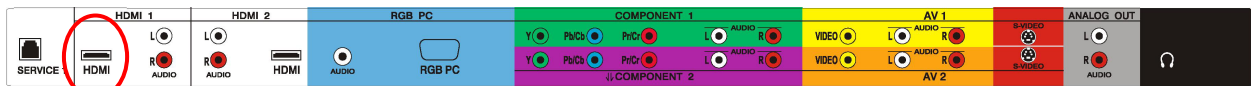

1. Turn off the power to the Plasma TV and HDTV Set-Top Box.
2. Connect a HDMI cable to the HDMI output of your HDTV Set-Top Box and the other end to the HDMI 1 Input (white color area) at the rear of the Plasma TV.
3. Turn on the power to the Plasma TV and HDTV Set-Top Box.
4. Select HDMI 1 using the INPUT button on the remote or side of the Plasma TV, or directly by pressing the HDMI button on the Remote Control.

**Note:**

- a) The HDMI input on the Plasma TV supports High-bandwidth Digital Content Protection (HDCP). HDCP encrypts the transmission between the video source and the digital display for added security and protection.
- b) If you are already using the HDMI 1 input for another component, or you do not want to use the HDMI 1 input for the Set-Top Box, you can connect the Set-Top Box to the HDMI 2 connection.
- c) Refer to your HDTV Set-Top Box user manual for more information about the video output requirements of the product or consult your cable or satellite operator.



**For Set-Top Boxes with DVI:**



1. Turn off the power to the Plasma TV and HDTV Set-Top Box.
2. Using a HDMI-DVI cable, connect the DVI end to your HDTV Set-Top Box and the HDMI end to the HDMI 1 Input (white color area) at the rear of the Plasma TV.
3. Using an audio cable (white and red connectors), connect the cable to the audio output connectors associated with the DVI output on your HDTV Set-Top Box and connect the other end to the audio connectors associated with the HDMI 1 input (white area) at the rear of the Plasma TV.
4. Turn on the power to the Plasma TV and HDTV Set-Top Box.
5. Select HDMI 1 using the INPUT button on the remote or side of the Plasma TV, or directly by pressing the HDMI button on the Remote Control.

**Note:** The HDMI Input is for HD Video and will only support 640x480 at 60Hz from a PC. Use the RGB PC input for a greater selection of PC formats.

**Note:**

- d) The HDMI input on the Plasma TV supports High-bandwidth Digital Content Protection (HDCP). HDCP encrypts the transmission between the video source and the digital display for added security and protection.
- e) If you are already using the HDMI 1 input for another component, or you do not want to use the HDMI 1 input for the Set-Top Box, you can connect the Set-Top Box to the HDMI 2 connections.
- f) Refer to your HDTV Set-Top Box user manual for more information about the video output requirements of the product or consult your cable or satellite operator.



## 2.3.2 Using Component Video

### Connecting your Set-Top Box (Better):

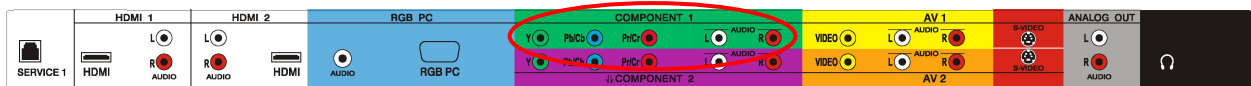

1. Turn off the power to the Plasma TV and HDTV Set-Top Box.
2. Connect the Y (green color) connector on your HDTV Set-Top Box to the corresponding Y (green color) connector in the Component 1 group (green color area - row of connectors nearest to you when viewing from the rear of the TV) at the rear of the Plasma TV.
3. Connect the Pb (blue color) connector on your HDTV Set-Top Box to the corresponding Pb (blue color) connector in the Component 1 group (green color area - row of connectors nearest to you when viewing from the rear of the TV) at the rear of the Plasma TV.
4. Connect the Pr (red color) connector on your HDTV Set-Top Box to the corresponding Pr (red color) connector in the Component 1 group (green color area - row of connectors nearest to you when viewing from the rear of the TV) at the rear of the Plasma TV.
5. Using an audio cable (white and red connectors), connect the cable to the audio output connectors associated with the Component output on your HDTV Set-Top Box and connect the other end to the audio connectors associated with the Component 1 input (green color area) at the rear of the Plasma TV.
6. Turn on the power to the Plasma TV and HDTV Set-Top Box.
7. Select Component 1 using the INPUT button on the remote or side of the Plasma TV, or directly by pressing the Component button on the Remote Control.

**Note:**

- a) If you are already using the Component 1 input for another component, or you do not want to use the Component 1 input for the Set-Top Box, you can connect the Set-Top Box to the Component 2 connections coded by the orange area.
- b) Refer to your HDTV Set-Top Box user manual for more information about the video output requirements of the product or consult your cable or satellite operator.





## 2.4 Connecting Your VCR or Video Camera

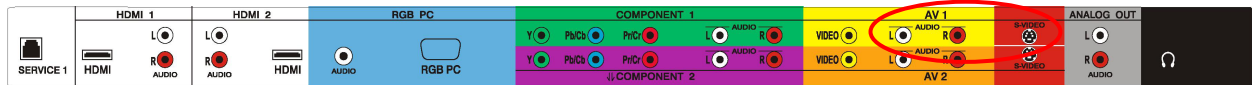

1. Turn off the power to the Plasma TV and VCR or Video Camera.
2. Connect the S-Video jack on the rear of your VCR or Video Camera to the S-Video jack in the AV1 group (red area) at the rear of the Plasma TV.
3. Using an audio cable (white and red connectors), connect the cable to the audio output connectors associated with the S-Video output on your VCR or Video Camera and connect the other end to the audio connectors associated with the AV1 input (yellow area) at the rear of the Plasma TV.
4. Turn on the power to the Plasma TV and VCR or Video Camera.
5. Select AV1 using the INPUT button on the remote or side of the Plasma TV, or directly by pressing the AV button on the Remote Control.

**Note:**

- a) If you are already using the AV1 input for another component, or you do not want to use the AV1 input for the VCR or Video Camera, you can connect the VCR or Video Camera to the AV2 connections coded by the orange/red area.
- b) Refer to your VCR or Video Camera user manual for more information about the video output requirements of the product.



## 2.5 Connecting Coaxial (RF)

### 2.5.1 Using Your Antenna or Digital Cable for DTV



1. Turn off the power to the Plasma TV.
2. Connect the coaxial (RF) connector from your antenna or digital cable to the DTV/TV CABLE/ANTENNA connector at the rear of the Plasma TV.
3. Turn on the power to the Plasma TV.
4. Select DTV using the INPUT button on the remote or side of the Plasma TV, or directly by pressing the TV button on the Remote Control.

**Note:**

- a) Not all digital TV broadcasts are High Definition (HD). Refer to the program guides, or consult your cable, satellite or TV station operator.
- b) Digital broadcasts are not available in all areas. Refer to [www.antennaweb.org](http://www.antennaweb.org) for detailed information.
- c) Make sure the antenna is correctly grounded.
- d) For Professional antenna installation contact VIZIO at [www.VIZIOCE.com](http://www.VIZIOCE.com) or call 1-888-VIZIOCE (1-888-849-4623).



## 2.5.2 Using Your Antenna or Cable for TV



1. Turn off the power to the Plasma TV.
2. Connect the coaxial (RF) connector from your antenna or cable to the DTV/TV CABLE/ANTENNA connector at the rear of the Plasma TV
3. Turn on the power to the Plasma TV.
4. Select TV using the INPUT button on the remote or side of the Plasma TV, or directly by pressing the TV button on the Remote Control.

## 2.5.3 Using the Antenna or Cable through your VCR



1. Turn off the power to the Plasma TV and VCR.
2. Connect the "Output to TV", "RF Out" or "Antenna Out" connector on the rear of your VCR to the DTV/TV CABLE/ANTENNA connector at the rear of the Plasma TV.
3. Turn on the power to the Plasma TV and VCR.
4. Select TV using the INPUT button on the remote or side of the Plasma TV, or directly by pressing the TV button on the Remote Control.

Note: If you have an off-air antenna or cable TV, connect it to the "Antenna In" connector on the rear of your VCR.



## 2.6 Connecting an external Receiver/Amp

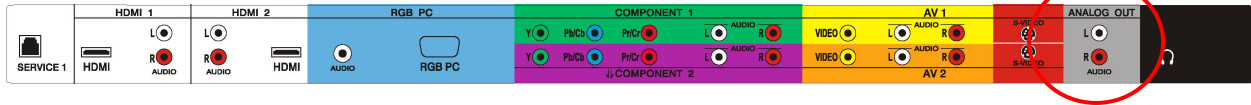

1. Turn off the power to the Plasma TV and Receiver/Amp.
2. Using an audio cable (white and red connectors), connect the cable to the audio input connectors on the Receiver/Amp and connect the other end to the ANALOG OUT (gray area) audio connectors at the rear of the Plasma TV.
3. Turn on the power to the Plasma TV and Receiver/Amp.
4. Then press the menu button on the remote control to open the On-Screen Display (OSD) menu.
5. Press the button on the remote control to select the Audio Adjust menu.
6. Press the button on the remote to select the Audio Settings menu.
7. Press the button on the remote to select Speakers.
8. Press the button on the remote to select Off so that the sound from the Plasma TV will now be routed through your Receiver/Amp system.

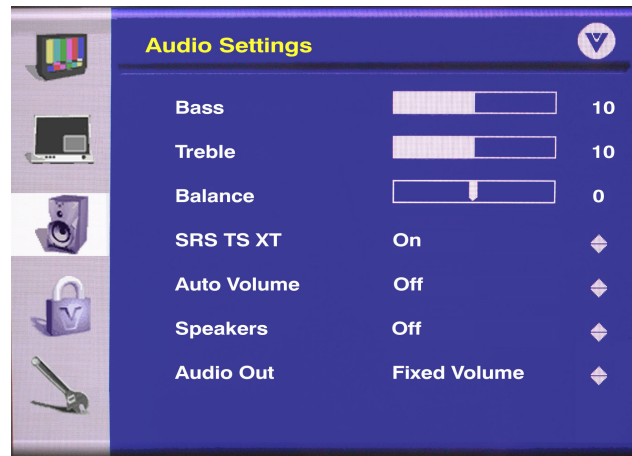

Note:

- a) Refer to your Receiver/Amp user manual to select the corresponding audio input.
- b) The audio output is not amplified and cannot be connected directly to external speakers.

### Optical Output of Audio received with HD Programs

If your sound system has a SPDIF (optical) digital audio input you can connect it to the optical DIGITAL AUDIO OUT (gray area) at the rear of the Plasma TV. This is active when receiving digital audio with the programs from the DTV/TV CABLE/ANTENNA input.



## 2.7 Connecting a PC Computer

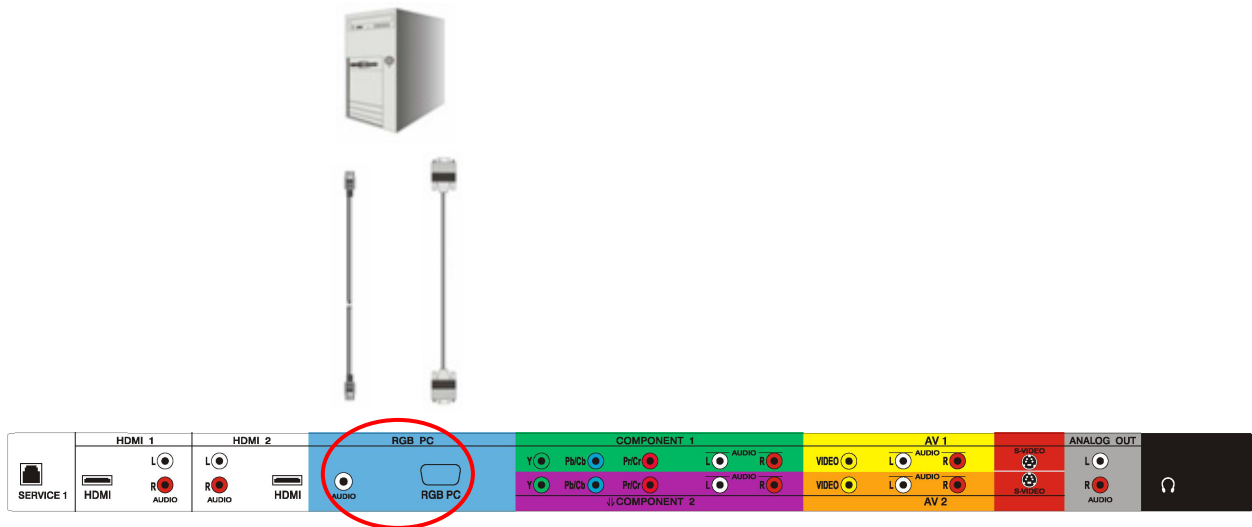

1. Turn off the power to the Plasma TV and PC Computer.
2. Connect a 15-pin D-Sub RGB (VGA) cable to the RGB output of your pc computer and the other end to the RGB PC input (blue area) at the rear of the Plasma TV.
3. Connect the Audio Out on your pc computer to the RGB PC Audio input (blue area) at the rear of the Plasma TV.
4. Turn on the power to the Plasma TV and PC Computer.
5. Select RGB using the INPUT button on the remote or side of the Plasma TV, or directly by pressing the RGB button on the Remote Control.

### Note:

- a) For the best picture quality when connecting a pc computer through RGB PC, set your pc computer timing mode to VESA 1024x768 at 60Hz. Please refer to the pc or graphic card's user guide for additional information on how to set the timing mode.
- b) Refer to your pc computer user manual for more information about the video output requirements of the product.
- c) A RGB (VGA) cable and stereo mini jack cable are not included and can be purchased at an electronics store.



## Chapter 3 Setting Up to Watch Television

For 'Preparing Your Plasma TV for Wall Mounting', see page 6.

### 3.1 Basic Plasma TV Start Up

1. **Connecting the Power Cable**  
Connect the power cord to the power cord connector on the back of the Plasma TV, and then plug the power cord into an AC wall socket.
2. **Connect Audio and Video Cables to the Plasma TV**  
(see pages 16 ~ 29 for detailed steps)
3. **Turning Power On**  
Once all the components are connected, press the Power ON button on the side of the Plasma TV, or press the Power ON (Red) button on the remote control.
4. **Select Input Source**  
Select the Input Source for the Plasma TV by pressing the INPUT button on the side of the TV or using the Input button on the remote control. Pressing this button will cycle through the following options: DTV, TV, RGB, AV1 (S-Video or Video\*), AV2 (S-Video or Video\*), Component 1, Component 2, HDMI 1 and HDMI 2.

\*S-Video has priority. If a signal is connected to AV1 S-Video by itself or signals are connected to AV1 S-Video and AV1 Video simultaneously, then S-Video will be the only choice for AV1. If a signal is connected to AV1 Video only, then Video will be the only choice for AV1. The same input priority scheme applies to AV2.

5. **Using TV with an Antenna or Cable**  
When an antenna or cable source is connected to the DTV/TV input, you will need to select TV using the INPUT button on the remote or side of the Plasma TV, or directly by pressing the TV button on the Remote Control, and Auto Scan for the available TV channels.

**Channel Scan Required**  
**Press Menu**

Please follow the instructions below:





- a. Select TV input (see Step 4 above) by pressing the INPUT button on the side of the Plasma TV or using the INPUT button on the remote control, or directly by pressing the TV button on the remote control. The screen will show 'snow' and an information panel that says, "Channel Scan Required Press Menu."

Note: If you do not see this option within the OSD, you might have selected the wrong input in the previous steps and you will need to repeat step 4 (above) to select the correct input source.

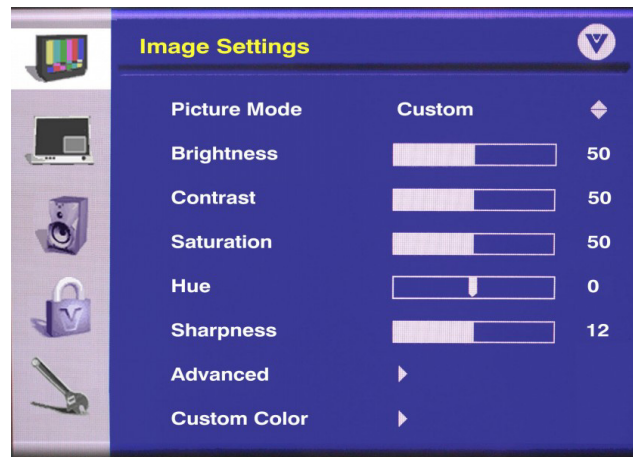





- b. Press the MENU button on the remote control to open the OSD menu. The Image Settings Menu will be displayed.

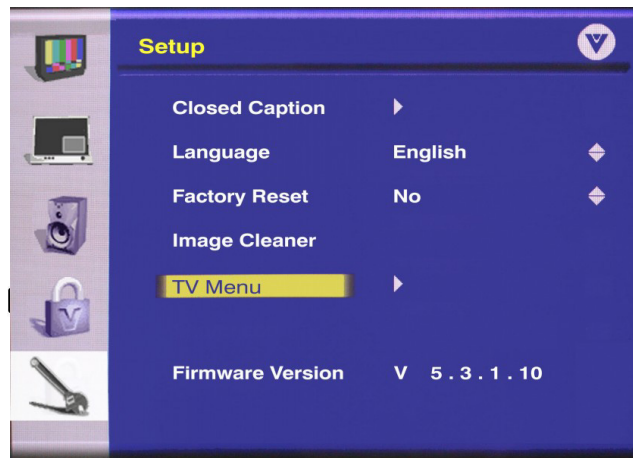



- c. Press the  button on the remote control once to highlight the Setup menu.
- d. Press the  and  buttons to highlight the TV Menu sub-menu. Press the  button to select this sub-menu.



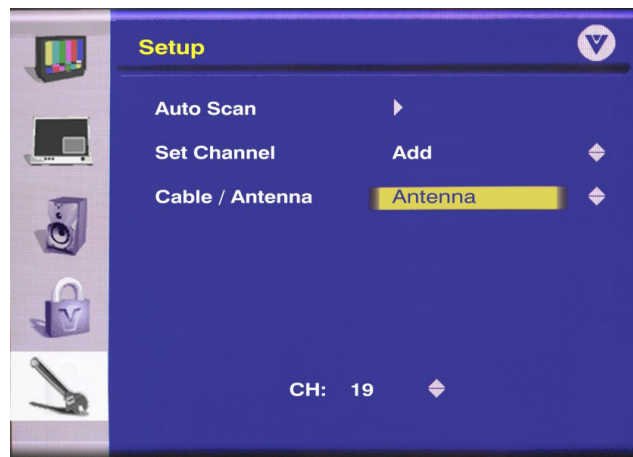



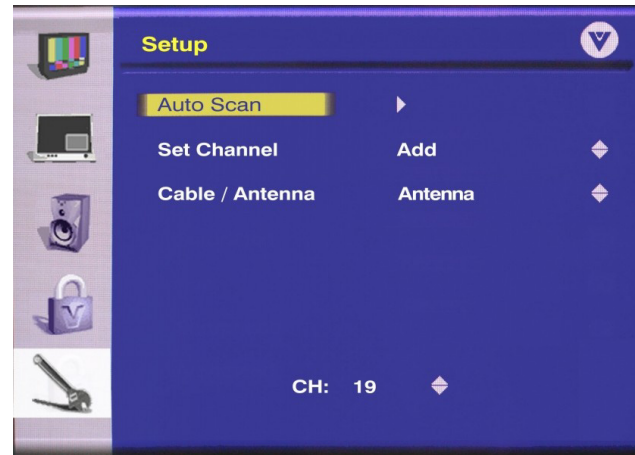

- e. Once selected, press the  button to highlight Cable / Antenna. Press the button to adjust this option and then press the  or  button to select the Cable or Antenna to match the source you have connected to the DTV/TV input at the rear of the Plasma TV.
- f. Press the  button when you have finished your selection.



- g. Press the  button until Auto Scan is highlighted.
- h. Use the  button to start the search. When finished, "Auto Scan Completed" will be displayed at the top of the screen. Note: This will take a few minutes to complete.



- i. To add or delete a channel press the  button to highlight CH and then press the  or  buttons until the desired channel number is shown.
- j. Press the  button to highlight Set Channel and then press the  button to select this option. Use the  or  buttons to Add or Skipped.
- k. Press the MENU button repeatedly to exit the On Screen Display (OSD).

#### 6. Using DTV with an Antenna or Cable

To use the Digital TV option, you will need to select DTV using the INPUT button on the remote or side of the Plasma TV, or directly by pressing the TV button on the Remote Control. The first time you use your DTV input you will see the information panel, "Channel Scan Required Press Menu" Press the MENU button and follow the procedure in Section 3.4 DTV Tuner Setup. Note: DTV digital broadcast is not available in all areas. Refer to

[www.antennaweb.org](http://www.antennaweb.org) to get information about availability in your area, type of antenna and in which direction to point your antenna. The channel availability through cable depends upon which channels your cable operator supplies in Clear QAM; consult your cable operator for more information.

**Channel Scan Required  
Press Menu**

#### 7. Using a PC

If connecting to a PC through the RGB PC input, set the TV timing mode to VESA 1024x768 at 60Hz for best picture quality (refer to the graphic card's user guide for questions on how to set this timing mode).





## 3.2 Watching a TV Program

Before you start watching TV, please make sure that any cable, satellite or off-air antenna connections are secure. Also, verify that the power cord is plugged into a correctly grounded electrical outlet or surge protector.

1. Press the power button on the remote or on the side of the Plasma TV. The status LED on the front will change to solid green.
2. There are 4 options for selecting your programming:
  - a. If you are using an antenna or cable connected through the DTV CABLE/ANTENNA input, you can select DTV using the INPUT button on the side of the Plasma TV.
  - b. If you are using an antenna or cable connected through the TV CABLE/ANTENNA input, you can select TV using the INPUT button on the side of the Plasma TV.
  - c. If you are watching broadcasts through a cable or satellite set-top box connected by an HDMI cable, select HDMI using the INPUT button on the side of the Plasma TV.
  - d. If you are watching broadcasts through a cable or satellite set-top box connected by a Component (YPbPr) cable, select Component 1 or Component 2 using the INPUT button on the side of the Plasma TV.

Note: You should be able to see a picture. If you do not, make sure that all of the Plasma TV connections are secure and you have selected the correct video input source.

3. Press the Channel buttons on the remote or the +/- buttons on the side of the Plasma TV to change the channel. Note: The Channel buttons, on the side of the Plasma and on the remote, control will not work if you are watching a program using HDMI 1 HDMI 2, Component 1, Component 2, AV1 or AV2 inputs.

## 3.3 Adjusting Basic Plasma TV Settings

### Volume

To increase the volume, press and hold the VOL+ or VOL- button on the side of the Plasma TV or remote control until the desired level is reached.

### TV Channels

To step up or down through the available TV channels, press the CH+ or CH- button on the side of the Plasma TV or remote control once for the next or previous channel, or hold it depressed until the desired channel is reached. Note: Channel up and down will only operate in DTV and TV modes.

### Wide

Using this feature, you can watch video content in different size modes on the TV. Press the WIDE button on the remote control to switch among the modes.

For more information see Section 3.5.11.





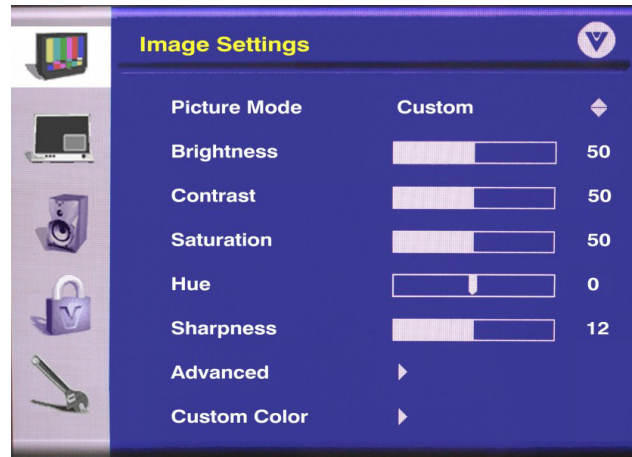

### 3.4 DTV Tuner Setup

Select the DTV input (see Step 4 on page 30) by pressing the INPUT button on the side of the Plasma TV or using the INPUT button on the remote control, or directly by pressing the TV button on the remote control.



Press the MENU button on the remote control to open the OSD menu. The Image Settings Menu will be displayed.



Press the  button on the remote control to highlight the Setup menu.

Press the  and  buttons to highlight the DTV Menu sub-menu. Press the  button to select this sub-menu. This will display the DTV TUNER SETUP menu.





The DTV Tuner Setup sub-menu is now shown on the screen. The DTV Tuner Setup option should be highlighted, if not, use the  or  button to highlight it.

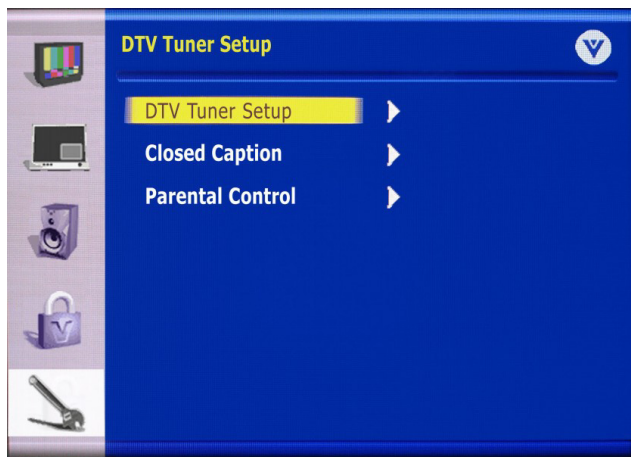

Press the OK button on the remote control and the next DTV Tuner Setup sub-menu will be shown.



**Time Zone** – Setting the correct Time Zone for your area will ensure that the correct program times are shown after pressing the GUIDE button on the remote control.

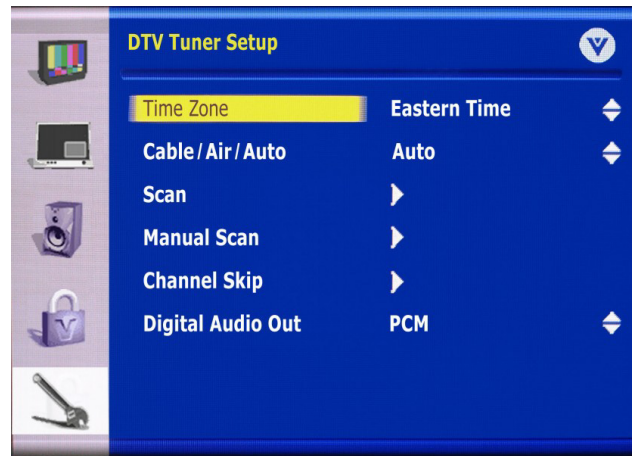

If necessary, highlight the Time Zone feature by using the  or  button. Press the  button to select this option.



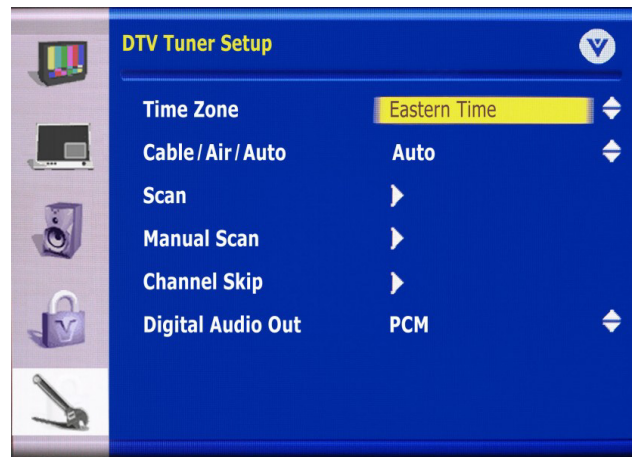



Select your time zone using the  or  button. When finished, press the  button to save and exit this option.

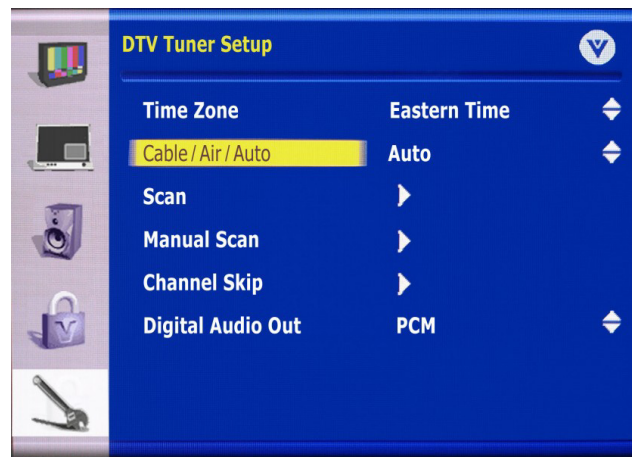

**Cable/Air/Auto** – The default selection is Auto. This means that the TV will scan for antenna and cable channels and takes the most time. If you have an antenna connected choose Air, or if you have cable connected choose Cable, and the TV will take less time in searching for channels.

Press the  or  button on the remote control to select Cable/Air/Auto.



Press the  button to select this option. Using the  or  button, select Cable if you are using cable out of the wall, Air if you are using an antenna.

Press the  button to save and exit this option.



**Scan** – Press the  button to highlight Scan. Press the OK button to activate. **Note:** This will take a few minutes to complete.



Once Auto Scan has finished, press the  button to return to the previous menu. **Note:** If you press OK, the Auto Scan process will start again.

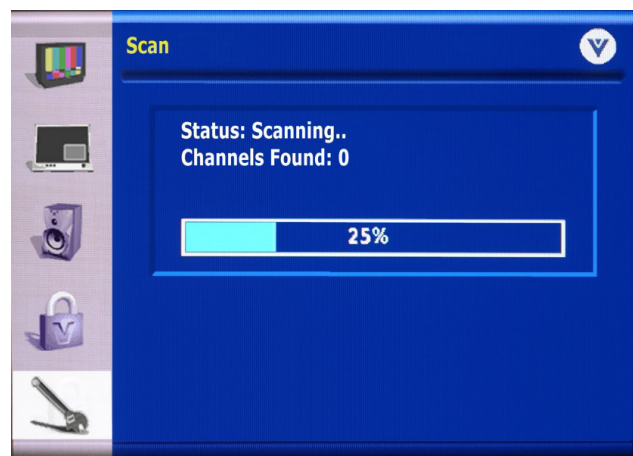

**Manual Scan** – If you feel that not all of the available digital TV channels were found with Auto Scan, then selecting this option enables the TV to scan again to try to find any missing channels. Press the  button to highlight Manual Scan and then press the OK button.

**Note:** A channel will be missed if it is not transmitting at the time of the scan and so you should try again at a time when you know the station is transmitting programs.



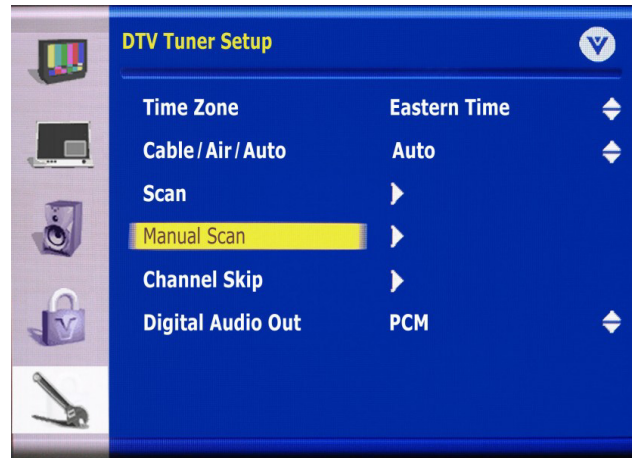

A channel will also be missed if it is too weak to be received. Re-orientation of the antenna or changing to a higher gain antenna may help, but note that any changes to the antenna may affect other channels.

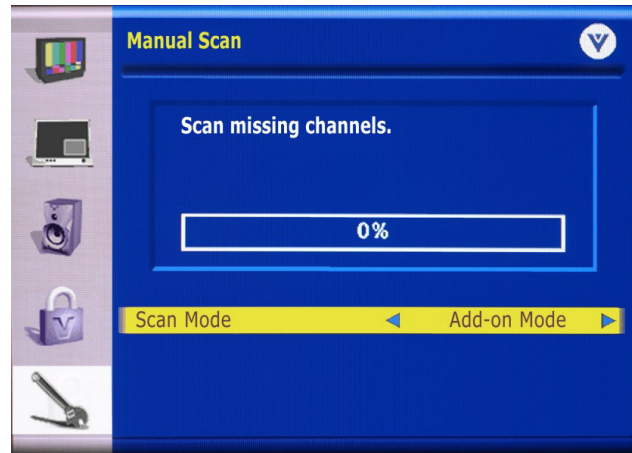

The Manual Scan screen now appears and this can be used in two ways. The screen defaults to Add-On Mode and pressing the OK button at this stage makes the TV scan the whole channel range again. Press EXIT to navigate away from this screen.

**Note:** If the OK button is pressed, then the automatic scanning will start again.



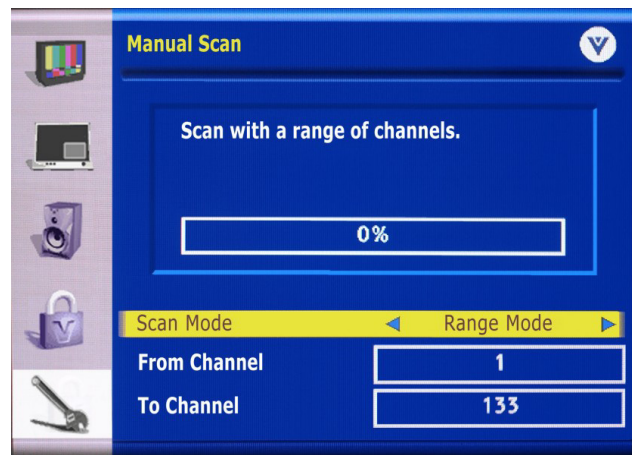

If the  or  button is pressed first, then the Range Mode is activated so that you can specify a smaller range of channels to be scanned again. Press the  button to highlight From Channel and enter the channel using the number buttons, then press the  button again to highlight To Channel and enter the channel using the number buttons. Press EXIT to navigate away from this screen.

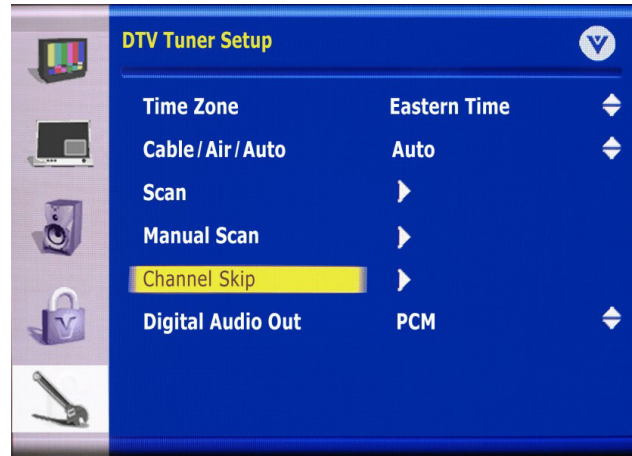

**Channel Skip** – Gives you the option to skip channels when using the Channel+ or Channel- buttons.

Press the  button to highlight Channel Skip. Press the OK button.



The list of channels available and stored in memory is shown on the screen. If the list is longer than 8 channels, as you repeatedly press the  button you will be able to scroll through to see them all. The boxes to the right of the channel names are empty by default.







As you scroll down the channels with the  button, each one is highlighted in turn. When a channel you want to skip is highlighted, press the OK button and a check mark (✓) will appear in the box opposite that channel. This means that when surfing with the CH+ or CH- buttons, this channel will be skipped and not displayed. Press EXIT to navigate away from this screen when finished.

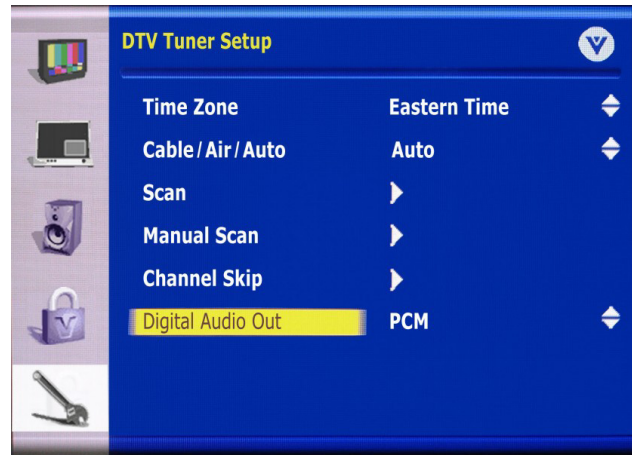

**Digital Audio Out** – You must set the configuration of the digital audio (SPDIF) on this sub-screen. Press the  button to highlight the Digital Audio Out option.

**Note:** Consult the user manual of your Receiver/Amp to determine the capabilities and requirements of that equipment.



Press the  button to select this option. Using the  or  button to select PCM, Dolby Digital or Off.







**Closed Caption** – Allows you to read the voice content of television programs. Open the OSD and find the Setup menu, (see Page 34 for instructions if necessary.)

Although this is digital TV, some broadcasts will have analog Closed Caption instead of digital Closed Caption and so the VIZIO TV can display either.

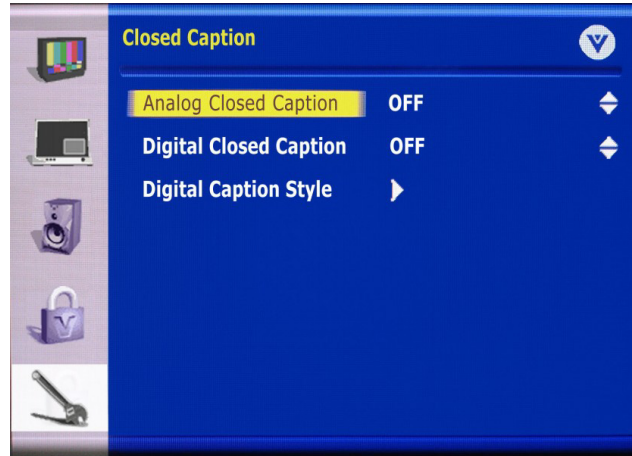
The settings on this menu page will set the default for all DTV channels. When viewing a channel, you can change the Closed Caption setting using the CC button on the remote but it will only affect that channel and if you change channels and come back to the original one, the Closed Caption setting will revert back to the one set here in the OSD.

To set Analog Closed Caption for all DTV channels, use the  button to highlight the Analog Closed Caption option.





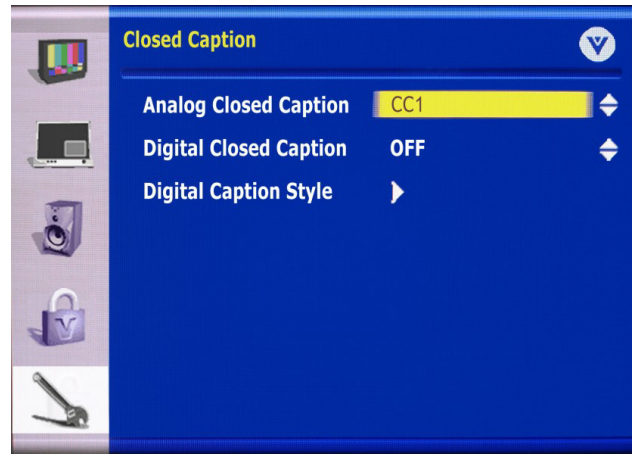

Press the  button to select this option. Using the  or  button to select the Closed Caption service required, usually CC1.

**NOTE:** Analog Closed Caption has priority over Digital Closed Caption and so, when selected, will be the default setting for all DTV channels.

Use the CC button on the remote to change the setting when viewing a channel.



To set Digital Closed Caption for all DTV channels, use the  button to highlight the Digital Closed Caption option.

Press the  button to select this option. Using the  or  button to select the Closed Caption service required, usually Service 1.

**NOTE:** The default setting for all DTV channels will now be Closed Caption On, Service 1 option.

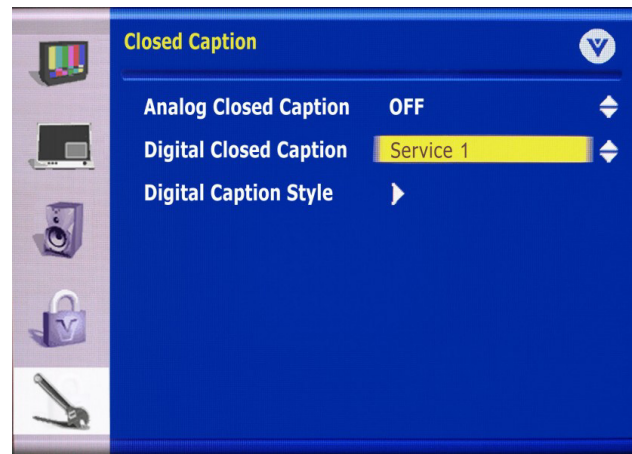





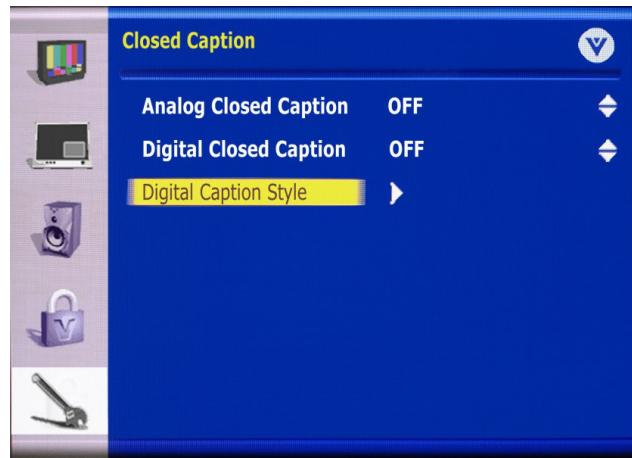

To set the look of the Digital Closed Caption information, highlight Digital Caption Style using the  button. Press the OK button.

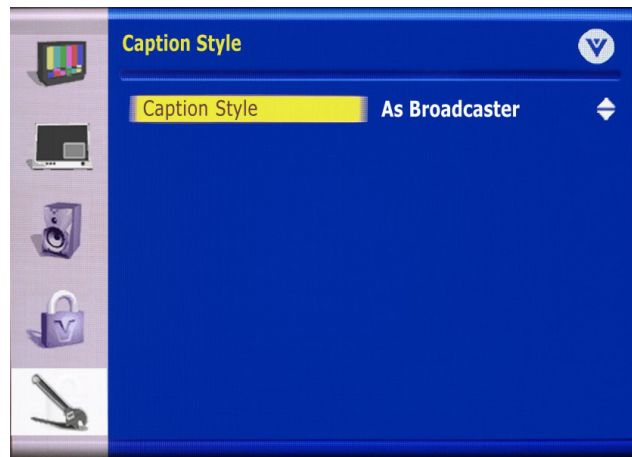

The default style, As Broadcaster, is shown as selected. This means that the style of the closed caption is as received from the TV channel. This is usually acceptable.



Press the  button to select this option. Using the  or  button to select Custom.

The Caption Style screen is now filled with many options to change the look of the Closed Caption information. Please note, this is only effective with digital channels and this has no effect on regular analog channels.



### 3.4.1 Parental Controls for DTV

Open the OSD and find the Setup menu, (see Page 34 for instructions if necessary.)

Press the  button to highlight the Parental Control option.

Press the OK button.

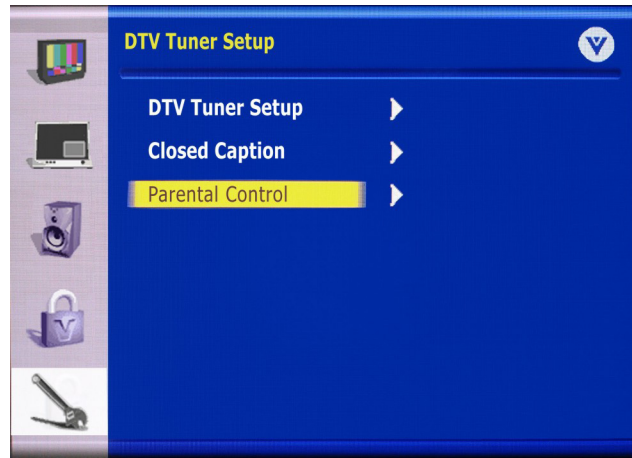

The Parental Control Password screen will be shown. Using the number buttons on the remote control, enter the four digit password. The factory default password is 0 0 0 0. If you change the password, please make a note of it in a safe place.

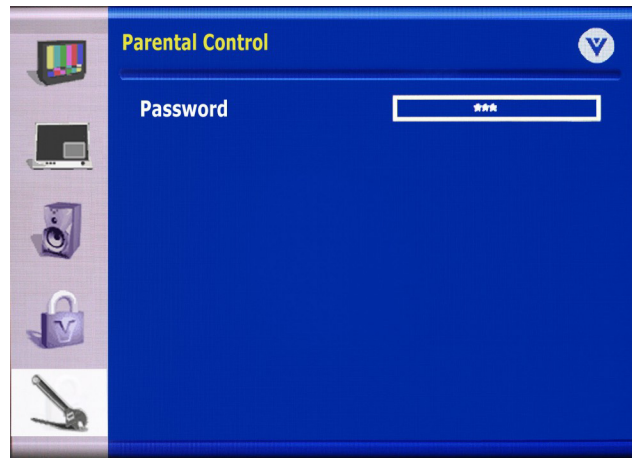

Once the correct password has been entered, the option for blocking channels becomes available. Press OK.

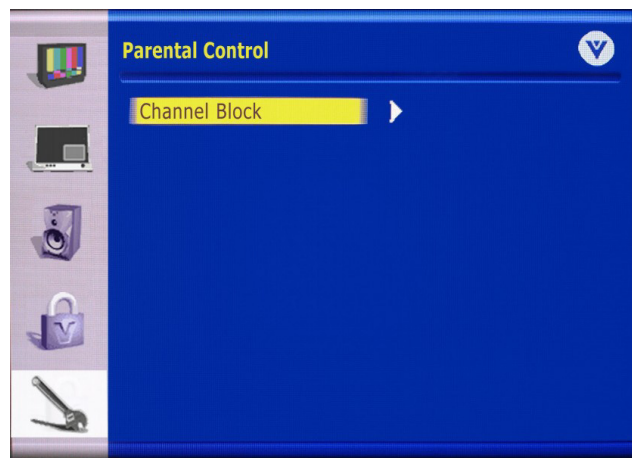

The list of channels available and stored in memory is shown on the screen. If the list is longer than 8 channels, as you repeatedly press the  button you will be able to scroll through to see them all. The boxes to the right of the channel names are empty by default.



As you scroll down the channels with the  button, each one is highlighted in turn. When a channel you want to block is highlighted, press the OK button and a check mark (✓) will appear in the box opposite that channel. This means that when this channel is selected a password request bar will appear on the screen and you will not be able to view this channel without first entering the password. Press EXIT to navigate away from this screen when finished.

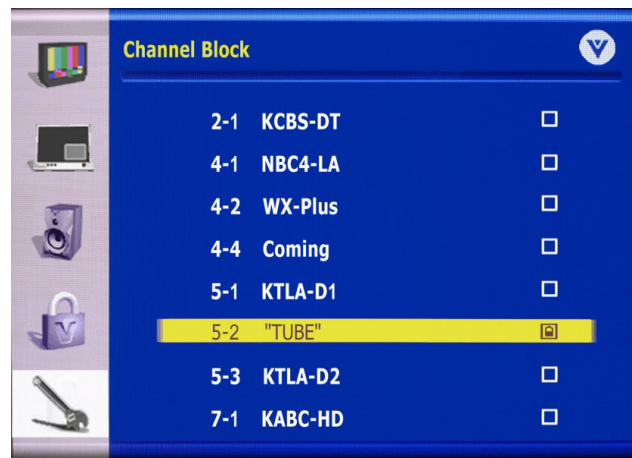

**NOTE:** If you use the Clear All function on the main Parental Controls menu, it will NOT clear any channels that are selected as Blocked on this page. Channels blocked on this page can only be Unblocked individually on this page.



### 3.4.2 DTV Channel Information

When a channel is selected, an information header is shown over the picture for a few seconds. This information consists of the channel number and name, the format in which the program is broadcast (480i SD, 480P SD, 720P HD, 1080i HD), audio channel 1/2 or 2/2 (omitted if alternate channel is not broadcast), language, program title, program start and end time, program rating and if CC is available.

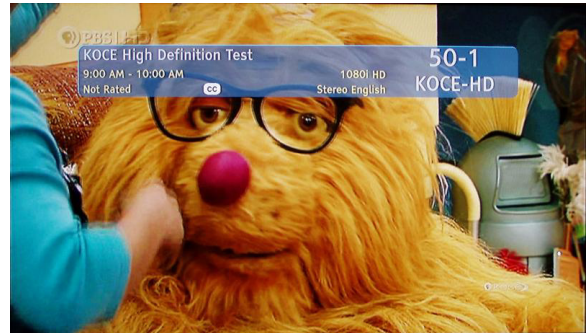

When you press the INFO button on the remote, you not only get the information header displayed, but also a short summary of the program content when available from the broadcaster. If you do nothing else with the INFO button, these panels will remain on the screen, even when changing channels.

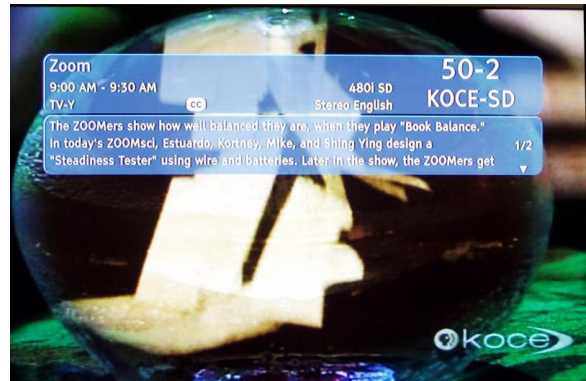

Press the INFO button and the program summary will disappear, but the information header will remain.





Press the INFO button again and only the channel number and name will remain. Press the INFO button one more time and this will disappear.



### 3.4.3 Program Information

Press the GUIDE button on the remote and program information for the channel you are watching will be displayed on the screen with the live program content in a small window in the lower left corner of the panel.





Press the  or  button to scroll up or down the channels. Each time you pause at a channel, the program list will update with the program schedule for the channel and the window will show the live program for that channel. Press the GUIDE button to exit this feature.



### 3.4.4 Setting a Password

You control access to the Parental Control features with a password. The default password is "0000". You can change the password to any four-digit number.

To change the password:



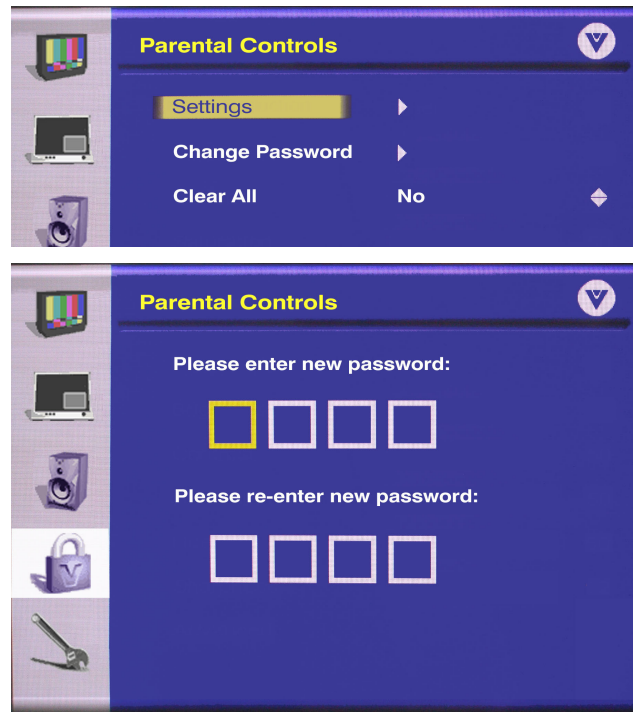

1. Press the MENU button to open the main On Screen Display (OSD) menu.
2. Press the  button on the remote control three times until the Parental Control menu opens. Press OK.
3. Enter your password. If you have not set a password, use the Number Buttons to enter the default password "0000".
4. Press the  button on the remote control to highlight Change Password. Press OK.
5. Enter your new password.
6. Enter the new password again in the Confirm area.
7. Press OK.
8. Press MENU repeatedly to exit the menu.



**Note:**

- a) Make sure you write down and store the new password in a secure place. The reset option in the Special Features menu (Section 3.5.9) does not reset the password.
- b) The DTV Parental Control password will always be the same as this one.

To reset the password:

1. Press the MENU button on the remote control and the Main Menu will be displayed on the screen, as shown opposite.
2. Press  until the Parental Controls menu is highlighted. Then press OK.
3. When the **first** box is highlighted in the Password option, press the , ,  and  buttons in the exact sequence.
4. Then press the OK button.
5. The password has now been reset to "0000" and the following message will appear.

**Your Password has  
been reset to 0000**





## 3.5 Using the On Screen Display (OSD)

The remote control or the control buttons on the right hand side of the TV can control all the function settings. The On Screen Display (OSD) allows you to adjust the save contrast, brightness and other settings. The TV will save changes made to the settings, even if the TV is turned off.

### 3.5.1 OSD Menu Operations

The OSD consists of several menu options: Image Settings, Display Settings, Audio Adjust, Parental Controls, and Setup. The main menu options may vary depending on your selected input source.

Note: Some of the main menu options may have additional submenus, i.e. the TV Rating submenu for Parental Controls.

1. Press the MENU button on the front of the TV or the MENU button on the remote control. The Main Menu will be displayed on the TV screen.
2. Use the CH+ or CH- buttons on the side of the Plasma TV, or the  or  button on the remote control to select one of the submenus:



**Image Settings**



**Display Settings**





**Audio Settings**



**Parental Controls**



**Setup**

3. Once the submenu is highlighted, use the Vol+ button on the side of the Plasma TV, or the  buttons on the remote control to select a menu option.
4. Use the CH+ or CH- buttons on the side of the Plasma TV, or the  or  button on the remote control to select the options settings.
5. Press the OK button on the remote control to confirm the feature.
6. Repeat steps 2 through 5 to adjust additional options within this menu.
7. Once the adjustments are completed, press the EXIT button on the remote control to exit the OSD completely.



### 3.5.2 Image Settings for Video Inputs

*Note: there are different image setting options when the RGB input is selected. Please see section 3.5.4 – Image Settings (for PC) on page 49 for additional information.*

**Picture Mode** – Options include Custom, Vivid, Movie, Game, and Sport.

**Custom** – allows the user to manually customize individual image settings.

**Vivid** – automatically increases the saturation level for an optimized picture.

**Movie** – automatically decreases the brightness and contrast level for an optimized picture.

**Game** – automatically increases the contrast level and slightly decreases brightness level for an optimized picture.

**Sport** – automatically increases contrast and saturation levels for an optimized picture.

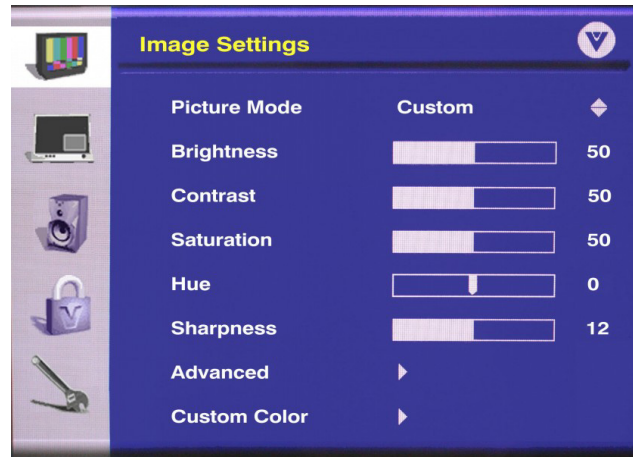

**Brightness** – Adjusts the black levels of the picture. You may need to readjust the brightness after the TV warms up.

**Contrast** – Adjusts the level of white between the lightest and darkest portions of an image. If the contrast is too low, picture appears dark and lacks detail. If the contrast is too high, the picture appears faded and lacks shadow and depth.

**Saturation** – Adjusts the levels of white and color in the picture. Highly saturated colors tend to be deep and strong while unsaturated colors are weaker and lighter.

**Hue** – Adjusts to make the flesh tones more natural.

**Sharpness** – Adjusts the clarity of the picture. If the sharpness is set too high, hard edges in the picture appear to have a ghost image.

**Advanced** – Please see below for additional information regarding these options.

**Custom Color** – Allows you to adjust the separate red, green and blue color levels to your individual preference.





### 3.5.3 Advanced Image Settings for Video inputs

When you select “Advanced” within the image settings submenu. The following options will appear.

**Noise Reduction** – when you select Noise Reduction, the following submenu options will appear:

**Motion (Motion Noise Reduction - MNR)** – This feature helps to remove picture noise caused by fast moving video that may be present in the picture.

**Digital (Digital Noise Reduction - DNR)** – This feature helps to remove picture noise caused by MPEG compression that may be present in the picture.

**Fleshtone** – Options include the following: Off, Low, Moderate, and High.

**Dynamic Contrast** – Changes the level of contrast for each screen. Select from 1 (minor) to 3 (strong).

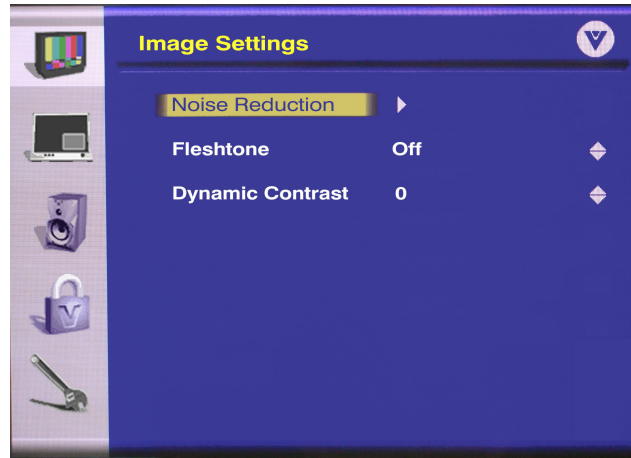

### 3.5.4 Image Settings (for PC)

The following menu options are available when RGB is the selected input.

**Brightness** - Adjusts the black levels of the picture. Users may need to readjust the brightness after the plasma monitor warms up.

**Contrast** – Adjusts the level of white between the lightest and darkest portions of an image. If the contrast is too low, the picture appears dark and lacks detail. If the contrast is too high, the picture appears faded and lacks shadow and depth.

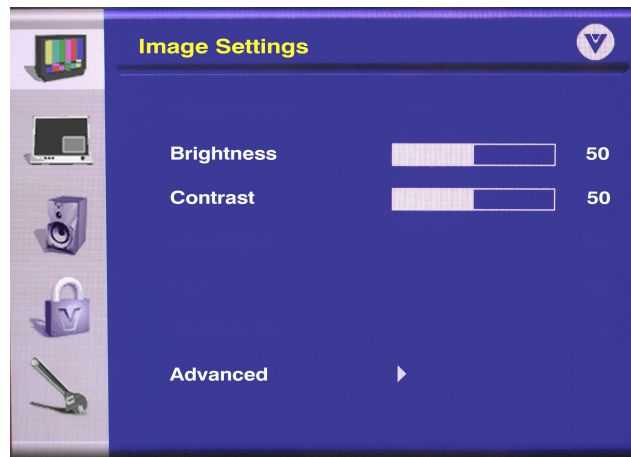

### 3.5.5 Advanced Image Settings for PC

**Auto Adjustment** - Automatically sets the position and size of the picture.

**Image Position** - Allows the user to manually set the position of the picture on the display.

**Phase** – Removes any horizontal distortion and clears or sharpens the displayed characters.

**Clock** – Removes any vertical distortion and clears or sharpens the displayed characters.

**Color Temp** - Options include standard, cool, warm or customized by the user.

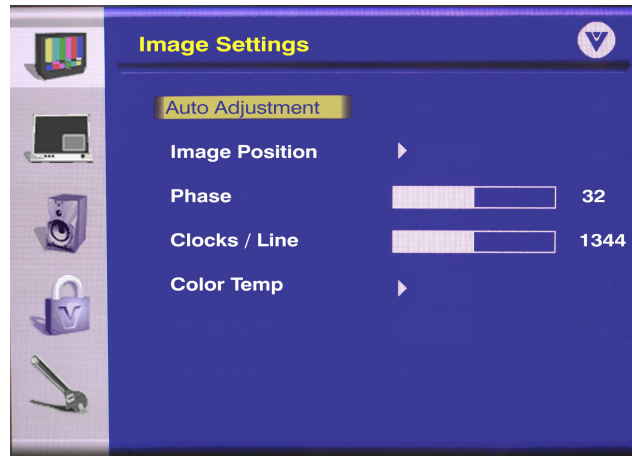

### 3.5.6 Display Settings

**Aspect Ratio** – Options include one of the following: Panoramic (available only in video mode), Normal, Wide and Zoom (not available for RGB input). For additional information, see Section 3.5.10 - Understanding Viewing Features on page 53.

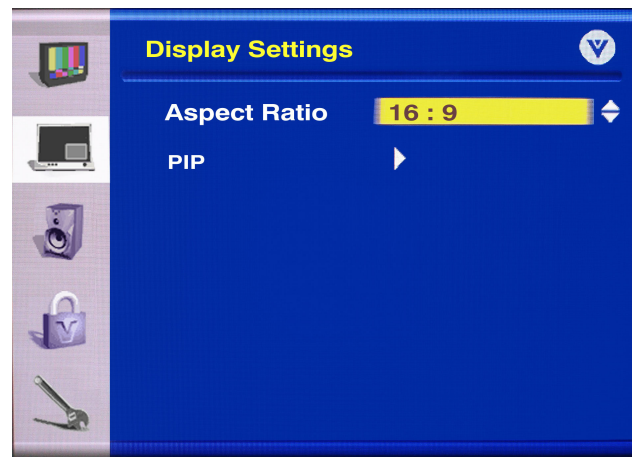

**PIP** – when you select PIP, the following submenu options will appear:

**PIP Mode** – Choose from the following: Off, Large PIP, Small PIP and POP.

**PIP Position** – Choose from the following: Top-Left, Top-Right, Bottom-Left, and Bottom-Right.

**PIP input** – Choose the input for the PIP source from one of the following: AV1 (S-Video or video\*), AV2 (S-Video or video\*), Component 1, Component 2, HDMI 1, HDMI 2, and RGB.

*\*S-Video has priority. If a signal is connected to AV1 S-Video by itself or signals are connected to AV1 S-Video and AV1 Video simultaneously, then S-Video will be the only choice for AV1. If a signal is connected to AV1 Video only, then Video will be the only choice for AV1. The same input priority scheme applies to AV2.*

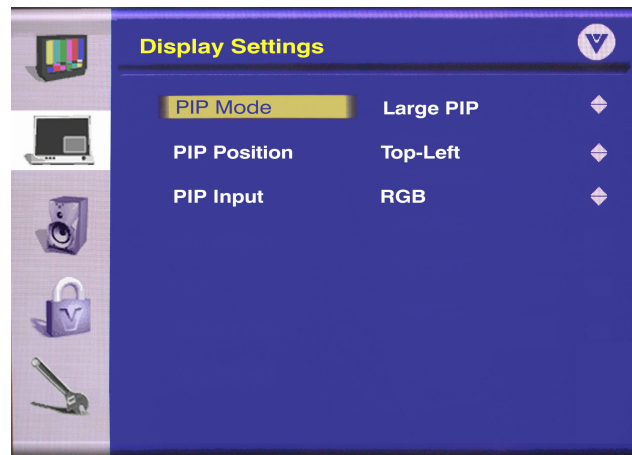

For additional information regarding the PIP source options, see section 3.5.12 - Picture-in-Picture (PIP) Mode on page 54.



### 3.5.7 Audio Settings

- Bass** - Adjusts the bass.
- Treble** – Adjusts the treble.
- Balance** – Adjusts the balance level between the channels.
- SRS TS XT** – Selects either on or off for surround sound.
- Auto Volume** – Adjusts the volume so that each input is at the same level.
- Speakers** - Turns the internal speakers on or off.
- Audio out** – Options include Fixed Volume or Variable Volume. Note: this option is only available when the internal speakers are turned off.

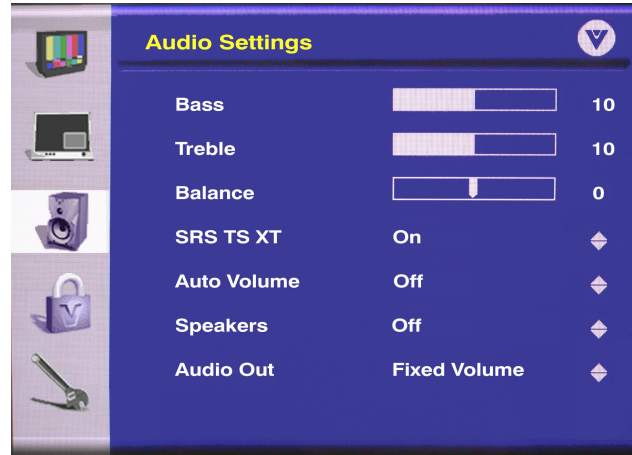

### 3.5.8 Parental Controls

Note: you will need to enter in a password to access the submenus. The default password is “0000”. It is advised that you change this password during the initial set up.

- TV Rating** - Sets the level of television programs that will be blocked without entering in the password. For more information, see Section 3.5.14 - Using the Parental Controls, page 55.
- Movie Rating** - Sets the level of movies that will be blocked without entering in the password. For more information, see Section 3.5.14 - Using the Parental Controls, page 55.
- Block Unrated** – Allows for the user to block programs that do not have any TV or Movie rating and are classified as “Unrated”.

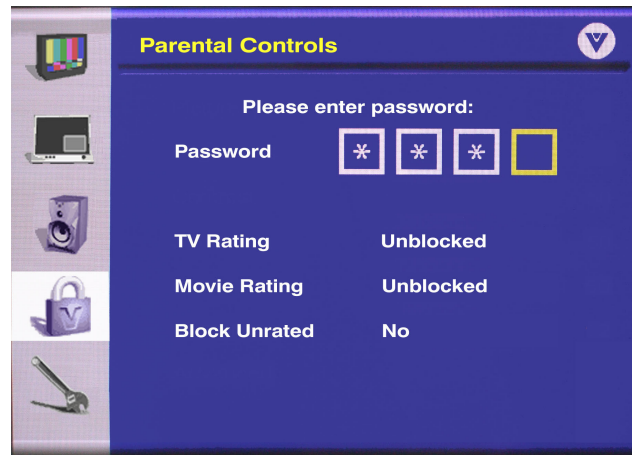

For more information on Parental Controls see Section 3.5.14 – Using the Parental Controls, page 55.



### 3.5.9 Setup

**Close caption** – Choose from one of the following: CC1, CC2, CC3, CC4, TEXT1, TEXT2, TEXT3, TEXT4

**Language:** Changes the language of the OSD menu. Options include English, Spanish and French.

**Factory Reset** - Resets the display back to the factory default settings.

**Image Cleaner (VIC):** – Removes ghosts of previous images.



**Note:** *Prolonged display of stationary images will cause them to remain on the screen. Higher brightness levels will make the panel more susceptible to retaining images. This feature will not remove images that have been displayed for too long. Image sticking is not covered under standard warranty.*

**Firmware Version** – Displays the version of the firmware.

When Close Caption is selected, the following options will appear:

**Display** – Choose from the following options: CC1, CC2, CC3, CC4, TEXT1, TEXT2, TEXT3, and TEXT4.

**Captions on Mute** – Enables Closed Caption to be displayed when the audio is muted.

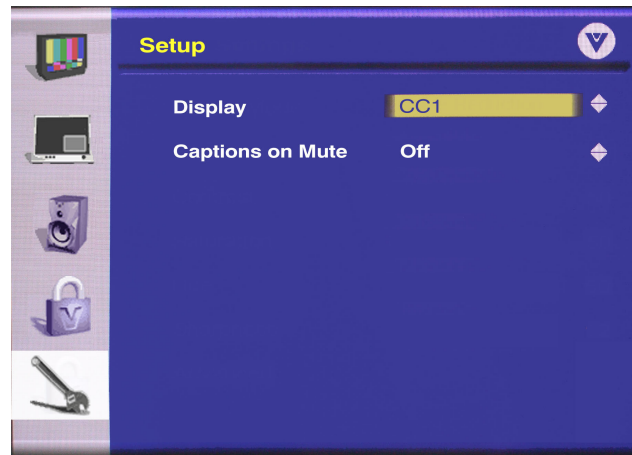

### 3.5.10 Understanding Viewing Features

Your Plasma TV features four viewing modes and Picture-In-Picture (PIP)/Picture-by-Picture (POP) mode. You can switch viewing modes using the On Screen Display (OSD) or the remote control. For more information on using the OSD, see Section 3.5.6 – Display Settings, page 50.

### 3.5.11 Viewing Modes

#### Normal Mode

The original 4:3 aspect ratio (1.33:1 source) is preserved, so black bars are added to the left and right of the display image. Standard TV broadcasts are displayed with a 4:3 Aspect Ratio. Movies in 4:3 Aspect Ratio may be referred to as pan-and-scan or full frame. These movies were originally filmed in 16:9 (widescreen), and then modified to fit a traditional TV screen (4:3).

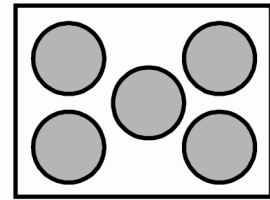

#### Wide Mode

When watching a standard broadcast or full-frame movie in this mode, the display image is stretched proportionately to fill the TV screen. When watching a widescreen (1.78:1 source) program or movie, the display image fills the TV screen. If you are watching a widescreen (1.85:1 or 2.35:1 source) program or movie, there will still be black bars at the top and bottom.

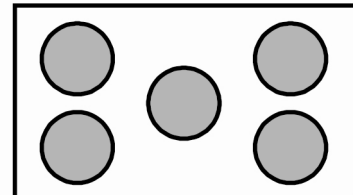

#### Zoom Mode

When watching a widescreen (1.78:1, 1.85:1, or 2.35:1 source) program or movie, the display image is zoomed proportionally to fill the width of the screen. The top and bottom are cut off to remove most of the source material's black bars. This mode is good for programs or movies with sub-titles.

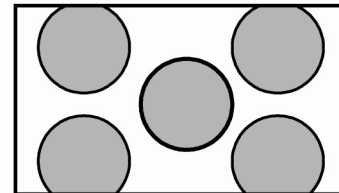

#### Panoramic Mode

When watching a standard broadcast or full frame movie in this mode, the 4:3 Aspect Ratio (1.33:1 source) display image is stretched horizontally on the left and right sides to fill the TV screen. The center of the image is not stretched.

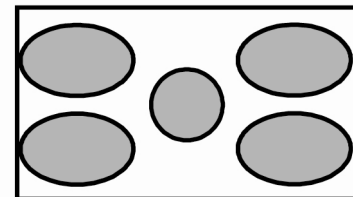

Note: Viewing modes and volume settings are saved based on input. For example, you last watched a DVD in widescreen mode and then watched TV in standard mode. When you switch back to DVD input, the viewing mode will return to widescreen.



### 3.5.12 Picture-In-Picture(PIP)/Picture-by-Picture(POP)Mode

Your TV features PIP mode so you can watch two pictures at the same time. When PIP is turned on, you can display two pictures at one time. One picture is displayed as the full screen (main screen) and the other picture is displayed in a small window (sub screen). The sub-screen can be set to small, medium or large.

See below for detailed information regarding the PIP sources.

MAIN \ SUB	SUB									
	DTV	TV	AV1	AV2	Component 1	Component 2	RGB	HDMI 1	HDMI 2	
DTV			✓	✓	✓	✓	✓	✓	✓	✓
TV			✓	✓	✓	✓	✓	✓	✓	✓
AV1	✓	✓		✓	✓	✓	✓	✓	✓	✓
AV2	✓	✓	✓		✓	✓	✓	✓	✓	✓
Component 1	✓	✓	✓	✓		✓	✓	✓	✓	✓
Component 2	✓	✓	✓	✓	✓		✓	✓	✓	✓
RGB	✓	✓	✓	✓	✓	✓		✓	✓	✓
HDMI 1	✓	✓	✓	✓	✓	✓	✓		✓	✓
HDMI 2	✓	✓	✓	✓	✓	✓	✓	✓		✓

“✓” – Indicates which inputs are available for PIP and POP modes.

\*When HDMI is used for the Sub-Screen it cannot support 1080i.

### 3.5.13 Adjusting Basic PIP/POP Settings

#### PIP Channel

The PIP channel is independent of the Main screen DTV/TV channel. To change the PIP screen channel, press the PIP CH + or - button on the remote control. To change the Main screen channel, press the CH + or - button on the remote control.

#### Swapping PIP/POP Video



You can swap the program that is in the main picture with the program in the PIP sub-picture. To swap the main picture program with the PIP sub-picture program, press SWAP on the remote control. If you press SWAP again, it will return the program to the main picture. This works the same if you are in the Picture-by-Picture (POP) mode.



### 3.5.14 Using the Parental Controls

The Parental Controls feature prevents viewers from watching programs that are not age-appropriate, such as programs containing violence or adult language.

Press the MENU button to open the main On Screen Display (OSD) Menu.

1. Press the  button until the Parental Controls menu is highlighted. Then press the  button.
2. Enter your password. If you have not set a password, use the Number Buttons to enter the default password "0000". *For more information about setting a password, please see Section 3.4.4 - Setting a Password, page 46.*



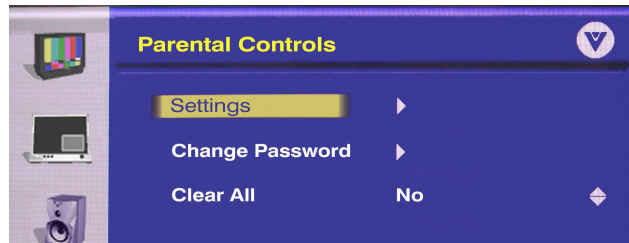

3. The Parental Controls page is now shown and the Settings option is highlighted. Press the  button.





4. The page content changes to the settings options, the TV Rating option being highlighted. Press the  button.







5. Press the  or  button to select which rating you want to block or unblock. You can select from the following ratings:
  - TV Youth (all children)
  - TV Youth 7 (older children)
  - TV G (general audience)
  - TV PG (guidance suggested)
  - TV 14 (strongly cautioned)
  - TV MA (mature audience)
  - Unblocked



Then Press OK.



6. Press the  or  button to select Blocked or Unblocked. Press OK.
7. Press Menu to back out of the menu.

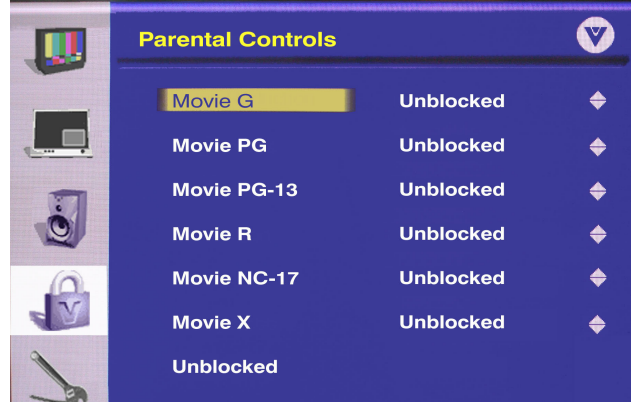

8. Press the  button to highlight Movie Rating. Press the  button.
9. Press the  or  button to select which rating you want to block or unblock. You can select from the following ratings:
  - Movie G (General audience)
  - Movie PG (Parental guidance suggested)
  - Movie PG-13 (Recommended for children 13 years of age and older)
  - Movie R (mature audience)
  - Movie NC-17 (no one under 17 years of age)
  - Movie X (no one under 17 years of age)
  - Unblocked





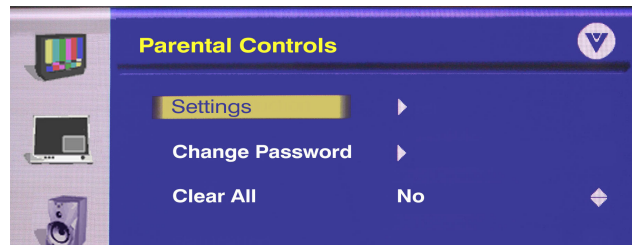

Then Press OK.

11. Press the  or  button to select Blocked or Unblocked. Press OK.
12. Press Menu repeatedly to exit the menu.

To change the Password for Parental Controls access, press the  button to highlight Change Password and then press the  button. See Section 3.4.4 – Setting a Password, page 46.



To clear all blocked settings, (except DTV blocked channels, see Section 3.4.1 – Parental Controls for DTV), press the  button to highlight Clear All. Press the  button to select the option and then press the  or  button to choose Yes.





## 3.6 Programming the VIZIO Universal Remote Control

You can program the remote control to work with up to four different components. Listed below are the steps for programming your VCR, Cable Box and DVD Player.

### 3.6.1 Programming for VCR

1. Manually turn on the VCR.
2. Press the VCR button on the remote control.
3. Press and hold the SETUP button until the LED LIGHT flashes twice.
4. Find the programming code for your VCR in the code list in the back of this book and enter it using the Number Buttons. If the code is accepted, the LED flashes twice after the last digit is entered.  
If the LED does not flash twice, repeat Steps 2 through 4 with the next code listed for the component and manufacturer.
5. Point the remote control at the VCR and press the POWER button. The VCR will turn off.

**Note:**

- a) If your VCR does not respond, try all the codes for your VCR brand. If the codes do not work, or your brand is not listed, see "Searching for Component Codes."
- b) Sometimes a code listed will only include limited functions. Try other codes that may include more functionality.

### 3.6.2 Programming for Cable Set-Top Box

1. Manually turn on the Cable Box.
2. Press the CBL button on the remote control.
3. Press and hold the SETUP button until the LED LIGHT flashes twice.
4. Find the programming code for your Cable Box in the code list in the back of this book and enter it using the Number Buttons. If the code is accepted, the LED flashes twice after the last digit is entered.  
If the LED does not flash twice, repeat Steps 2 through 4 with the next code listed for the component and manufacturer.
5. Point the remote control at the Cable Box and press the POWER button. The Cable Box will turn off.

**Note:**

- a) If your Cable Set-Top Box does not respond, try all the codes for your brand. If the codes do not work, or your brand is not listed, see "Searching for Component Codes."
- b) Sometimes a code listed will only include limited functions. Try other codes that may include more functionality.



### 3.6.3 Programming for DVD Player

1. Manually turn on the DVD Player.
2. Press the DVD button on the remote control.
3. Press and hold the SETUP button until the LED LIGHT flashes twice.
4. Find the programming code for your DVD player in the code list in the back of this book and enter it using the Number Buttons. If the code is accepted, the LED flashes twice after the last digit is entered.  
If the LED does not flash twice, repeat Steps 2 through 4 with the next code listed for the component and manufacturer.
5. Point the remote control at the DVD Player and press the POWER button. The DVD Player will turn off.

Note:

- a) If your DVD player does not respond, try all the codes for your brand. If the codes do not work, or your brand is not listed, see "Searching for Component Codes."
- b) Sometimes a code listed will only include limited functions. Try other codes that may include more functionality.

### 3.6.4 Searching for Component Codes

If you cannot find the manufacturer in the component list or the program code does not work, you can use the remote control to search for the correct component code.

To search for a component code:

1. Turn on the component.
2. Press the matching component button on the remote control.
3. Press and hold the SETUP button until the LED flashes twice.
4. Press 9 9 1. The LED flashes twice.
5. Point the remote control at the component and then alternate between pressing the POWER button and the component button on the remote control until the component turns off. If the component still does not respond, clear the component button, then repeat the search procedure.

### 3.7 Using a Cable or Satellite Remote

Your VIZIO remote uses codes 11758 and 10178 to work your Plasma TV. To use a cable or satellite remote to work the Plasma TV, refer to your cable or satellite remote user guide for more information on how to program the remote. If your cable or satellite remote uses a 5-digit code (like most Direct TV units), first try 11758 and then, if that does not work, 10178. If your cable or satellite remote uses a 4-digit code, try 1758 and then 0178 as an alternative. If your cable or satellite remote uses a 3-digit code (EchoStar or Dish Network for example), use code 627.

**Note:** Some buttons may not function as expected on your cable or satellite remote. Typically power, volume and mute will work.



## Chapter 4 Maintenance and Troubleshooting

### 4.1 Maintenance

#### Important

1. Make sure that the power cable is removed from the socket before cleaning the TV.
2. Do not use volatile solvent (such as toluene, rosin and alcohol) to clean the TV. Such chemicals may damage the housing, screen glass and remote control, and cause paint to peel.

#### Cleaning the Housing and Remote Control

1. Use the VIZIO soft cloth (included) for cleaning.
2. If the housing or remote control is seriously contaminated, use a soft cloth moistened with diluted neutral cleaner to clean the display. Wring water out of the cloth before cleaning to prevent water from penetrating into the housing. Wipe the display with a dry cloth after cleaning.

#### Cleaning the Screen

1. Use the VIZIO soft cotton cloth (included) to gently clean the screen.
2. The screen glass is very fragile. Do not scrape it with any sharp object. Do not press or tap the screen to avoid cracking. When the screen is seriously contaminated, use a soft cloth moistened with diluted neutral cleaner to clean the display. Wring water out of the cloth before cleaning to prevent water from penetrating into the housing. Wipe the display with a dry cloth after cleaning.

### 4.2 Troubleshooting Guide

If the TV fails or the performance changes dramatically, check the display in accordance with the following instructions. Remember to check the peripherals to pinpoint the source of the failure. If the display still fails to perform as expected, contact the VIZIO for assistance by calling 1-714-668-0588 or e-mail us at [techsupport@vinc.com](mailto:techsupport@vinc.com).

Problem	Solution
No power.	<p>Make sure the power button is ON (Green LED).</p> <p>Make sure AC power cord is securely connected to the AC socket.</p> <p>Plug another electrical device (like a radio) to the power outlet to verify that the outlet is supplying the proper voltage.</p>
No sound.	<p>Check your audio connection</p> <p>Press MUTE on the remote control again, so that MUTE disappears from the screen</p> <p>Check your audio settings, your TV audio may be set to SAP or minimum</p> <p>Press the Volume + (Up) key on your remote control</p> <p>Make sure that headphones are not connected</p>
If the screen is black.	Check your input connections.



Problem	Solution
Power is ON but no screen image.	<p>Make sure the video cable supplied with the TV is secured to the correct video output port on the back of the VCR and the TV. Make any cable you have attached to the TV is secured to the correct output your Set-Top Box, DVD, etc.</p> <p>Adjust brightness and contrast.</p> <p>Check Source settings.</p>
Wrong or abnormal colors appear.	<p>If any colors (red, green, or blue) are missing, check the video cable to make sure it is securely connected.</p>
Control buttons do not work.	<p>Press only one button at a time.</p>
Remote Control does not work.	<p>Make sure batteries are inserted correctly</p> <p>Batteries could be weak.</p> <p>Make sure you have selected TV on the remote.</p>
There appears to be image quality issues.	<p>For best image quality, view HD wide screen programs where possible. If HD content is not available view "Standard Definition" from a digital source. Standard, analog TV will always be noticeably inferior to HD because your digital flat panel TV has video that is many times better than old TV's and so you can see interference and deficiencies you did not know you had.</p>
You cannot see a picture.	<p>Make sure that the power cord is plugged into a grounded electrical outlet.</p> <p>Make sure that the power button is turned on.</p> <p>Make sure that the selected input source is connected to a working input source.</p> <p>If your TV is connected to your computer in RGB or HDMI mode, press any key on your keyboard to "wake" your computer.</p>
You see a distorted picture or hear unusual sound.	<p>You may be getting interference from electrical appliances, cars, motorcycles, or fluorescent lights. If you have not mounted it on the wall, try moving your TV to another location to see if this is the cause of the problem.</p>
The picture has abnormal patterns.	<p>Make sure that the input source cable is attached securely and correctly to the back of your TV.</p> <p>Make sure that the video input source is within the range of your TV. Compare the video input source's specifications with your TV specifications.</p>
The display image does not cover the entire screen.	<p>If you are using RGB mode, make sure that H Size and V Position in the On Screen Display (OSD) are set correctly.</p> <p>If you are using TV, AV1, AV2, AV3 or Component with 480i input, use the WIDE button on the remote control to scroll through various screen modes.</p>
You can see a picture but you cannot hear sound.	<p>Make sure that the volume is not turned down.</p> <p>Make sure that the sound is not muted.</p> <p>Make sure that your audio input source cables are connected securely and correctly.</p>
The TV has pixels that are always dark or colored.	<p>Your Plasma TV is manufactured using an extremely high level of precision technology, however, sometimes some pixels of your Plasma TV may not display. Pixel defects within industry specifications are inherent to this type of product and do not constitute a defective product.</p>
You see "noise" or "trash" on the screen.	<p>When your Plasma TV's digital capabilities exceed a digital broadcast signal, the signal is up-converted (increased) to match your TV's display capabilities. Up-converting can cause noise or trash.</p>
You switch to a different input and the volume changes.	<p>The TV remembers the volume level from the last time you adjusted it. If the sound level is higher or lower from another source, then the loudness will change.</p>
You switch to a different input and the screen size changes.	<p>The TV remembers the viewing mode from the last time you used a particular input (AV1, AV2, AV3, Component 1, Component 2, HDMI, and TV).</p>



<p>Tips for High-Definition Users.</p>	<p>The Plasma TV is an ideal platform for viewing High Definition Content. Best Image Quality will be achieved by the HDMI, Component (YPbPr), DVI or RGB. However, due to variances in broadcast practices, it is possible some image distortions can occur.</p>
<p>Tips for Letterbox Content Users.</p>	<p>Letterboxed (or "Widescreen") versions of DVD movies are most commonly formatted for standard 4:3 Televisions. The Plasma TV has the capability of expanding this content so the entire screen is filled at the expense of image accuracy. To use this function, press the "ZOOM" key on the remote control and cycle among the available options.</p>

### 4.3 Telephone & Technical Support

Products are often returned due to a technical problem rather than a defective product that may result in unnecessary shipping charges billed to you. Our trained support personnel can often resolve the problem over the phone. For more information on warranty service or repair, after the warranty period, please contact our Support Department at the number below.

Customer support and quality service are integral parts of VIZIO's commitment to service excellence.

For technical assistance contact our VIZIO Technical Support Department via email or phone.

E-mail: [techsupport@vinc.com](mailto:techsupport@vinc.com)

Tel: (714)668-0588

Hours of operations:

- 6:00am – 6:00pm PST Monday – Friday
- 10:00am – 2:00pm PST Saturday – Sunday

Please have your VIZIO model number, serial number and date of purchase available before you call.

**VIZIO**

320A Kalmus Drive

Costa Mesa, CA 92626

Tel: (714) 668.0588 Fax: (714) 668-9099

Web: [www.VIZIOCE.com](http://www.VIZIOCE.com)



## 4.4 Compliance

Caution: Always use a power cable that is properly grounded. Please use the AC cords listed below for each area.

USA	UL
Canada	CSA
Germany	VDE
UK	BASE/BS
Japan	Electric Appliance Control Act

## 4.5 FCC Class B Radio Interference Statement

NOTE: This equipment has been tested and found to comply with the limits for a Class B digital device, pursuant to Part 15 of the FCC Rules. These limits are designed to provide reasonable protection against harmful interference in a residential installation. This equipment generates, uses and can radiate radio frequency energy, and if not installed and used in accordance with the instructions, may cause harmful interference to radio communications. However, there is no guarantee that interference will not occur in a particular installation. If this equipment does cause harmful interference to radio or television reception, which can be determined by turning the equipment off and on, the user is encouraged to try to correct the interference by one or more of the following measures:

1. Reorient or relocate the receiving antenna.
2. Increase the separation between the equipment and receiver.
3. Connect the equipment into an outlet on a circuit different from that to which the receiver is connected.
4. Consult the dealer or an experienced radio/TV technician for help.

Notice:

1. The changes or modifications not expressly approved by the party responsible for compliance could void the user's authority to operate the equipment.
2. Shielded interface cables and AC power cord, if any, must be used in order to comply with the emission limits.
3. The manufacturer is not responsible for any radio or TV interference caused by unauthorized modification to this equipment. It is the responsibilities of the user to correct such interference.



## Chapter 5 Miscellaneous Information

### 5.1 Specifications

Specifications	
Panel	50" Diagonal, 16:9 Aspect Ratio
Resolution	1366 x 768 pixels
Pixel (Dot) Pitch	0.81mm (H) x 0.81mm (V)
Display Compatibility	HDTV (720P)
Signal Compatibility	480i (SDTV), 480P (EDTV), 720P (HDTV), 1080i (HDTV)
Colors	231 Billion
Brightness	1,000 cd/m <sup>2</sup> (typical)
Contrast	10,000:1 (max)
Viewing Angle	>170° (horizontal and vertical)
Inputs	1x RF, 2x Composite Video plus Stereo Audio, 2x S-Video plus Stereo Audio, 2x Component YPbPr plus Stereo Audio, 1x Analog RGB plus Stereo Audio (shared with Digital Video), 2x Digital Video (HDMI™**) with HDCP plus Stereo Audio (RCA)
Outputs	1x 5.1 Audio from DTV input only (SPDIF Optical), 1x Stereo Audio (RCA), 1x Headphone (Stereo Mini-Jack)
Features	Single Scan Technology for Higher Contrast, Reduced Solarisation and Reduced False Contouring, PIP, POP, CC, V-Chip, 3D Comb Filter, Zoom, Freeze, DCDi® by Faroudja*** Motion Adaptive De-Interlace, 3-D Noise Reduction, Sharpness Improvement, Non-linear Chroma Enhancement, Closed Color Suppression, Non-Linear Scaling, Adaptive Contrast
Speakers	Built-in, 10W x 2
Panel Life	60,000 hours to half the original brightness
Power	
Input	IEC Connector for direct power line connection
Voltage Range	100 ~ 240Vac at 50/60Hz
Power Consumption	550W Max (490W average)
Environmental Conditions	
Operating	Temperature: 5°C~35°C, Relative Humidity: 20~80%, Altitude: 0~6,560 ft
Non-Operating	Temperature: -20°C~50°C, Relative Humidity: 10~90%, Altitude: 0~9,840 ft
Dimensions	48.8" x 34.3" x 12.2" (1241 x 871 x 310 mm) w/stand, 48.8" x 33.5" x 3.89" (1241 x 850 x 99 mm) w/o stand
Net Weight	85 lbs with stand; 76 lbs without stand
Gross Weight	144 lbs (65.2 kg)
Certifications	CSA, FCC Class B

\*Product specifications may change without notice or obligation.

\*\* HDMI, the HDMI logo and High-Definition Multimedia Interface are trademarks or registered trademarks of HDMI™ Licensing LLC.



## 5.2 Glossary - Standard Definitions

- Analog TV:** Today's TV system using radio frequency waves to transmit and display pictures and sound.
- Aspect Ratio (4x3):** Traditional TV "aspect ratio", that is, the screen's width as compared to its height. For example, a "32 inch TV screen" would be 25 inches wide and 19 inches tall.
- Aspect Ratio (16x9):** "Wide screen TV" aspect ratio which is more like a movie screen than a traditional TV. For example, a "32 inch TV screen" would be 28 inches wide and 16 inches tall.
- Digital TV (DTV):** Television delivered and displayed using radio frequency waves that contain information that is digitally encoded for improved quality and efficiency.
- Enhanced Definition TV (EDTV):** A better digital television transmission than SDTV with at least 480P, in a 16x9 or 4x3 display and Dolby digital surround sound. 480P is the quality used by most DVD players. EDTV provides 300-400,000 pixels.
- HDTV Monitor (sometimes called HDTV Ready):** A set that can display HDTV programming if you have a separate HDTV tuner, HD Cable Set-Top Box or HD Satellite Set-Top-Box Receiver.
- HDTV Tuner (also decoder, receiver, set-top box):** A device capable of receiving and outputting HDTV signals for display. It may be stand-alone or integrated in the set.
- High-Definition Television (HDTV):** The best quality picture, wide screen (16x9) display with at least 720 progressively scanned lines (720P) or 1080 interlaced lines (1080i) and Dolby digital surround sound. HDTV provides 900,000-2.1 million pixels.
- Integrated HDTV:** An HDTV that has the digital tuner built into the set. It does not need a separate set-top box to receive over-the-air DTV signals.
- Interlace Scan:** A way to scan vertical lines onto a TV picture by scanning all the odd lines first, then filling the in the even lines (this happens instantaneously).
- Plug-and-Play or Digital Cable Ready:** A DTV or other device for digital cable consumers that plugs directly into the cable jack and does not require a separate set-top box. Plug-and-Play TV owners must obtain a CableCARD from their cable company in order to view scrambled programming services.
- Progressive Scan:** A way to scan vertical lines onto a TV picture by scanning all the lines consecutively (progressively).
- Standard Definition TV (SDTV):** Basic digital television transmission that may be displayed with fewer than 480 progressively scanned lines (480P) in 16 x 9 or 4 x 3 format. 480 interlaced (480i) is the quality of today's analog TV system.

Source: Buying a Digital Television, CEA, HDTV Guide, 2005

**Note:** The Federal Communications Commission (FCC), the Consumer Electronics Association (CEA) and the Consumer Electronics Retailers Coalition (CERC) have made a new tip sheet available for digital television (DTV) retailers to reproduce and distribute to consumers on the sales floor. The file may be downloaded online at [www.dtv.gov](http://www.dtv.gov). While you're there, check out the other useful information in the FCC is making available to consumers interested in learning more about the analog to digital transition.





## 5.3 Index

### A

- Accessories, 5
- Adjustments
  - Choosing Channels to Skip when Channel Surfing, 38
  - Closed Caption, 13, 40
  - DTV Tuner Setup, 35
  - Parental Controls, 42
  - Password for Parental Controls, 46
  - Selecting the Screen Size, 13, 33, 53, 64
  - Setting the Digital Audio Output On or Off, 39
  - Stepping through TV Channels, 9, 33
  - Time Zone, 35
  - Volume, 9, 33, 59

### C

- Cleaning your VIZIO TV, 59
- Co-axial RF
  - Connecting for DTV, 26
  - Connecting for TV, 27
- Component
  - Connecting your DVD Player, 19
  - Connecting your Set-Top Box, 24
- Composite (AV)
  - Connecting your DVD Player, 21
  - Connecting your VCR, 25
  - Connecting your Video Camera, 25
- Controls
  - Front Panel, 9
  - Side Panel, 9

### D

- DVI
  - Connecting your DVD Player, 18
  - Connecting your Set-Top Box, 23

### E

- Extended Warranty, 68

### G

- Glossary, 64

### H

- HDMI
  - Connecting your DVD Player, 17
  - Connecting your Set-Top Box, 22

### I

- Information
  - DTV Channels, 44



- Programs, 45
- Inputs
  - Antenna, 3
  - Connectors, 16
  - Rear Label, 10
- Installation
  - Base removal, 6
  - Preparation, 5
  - Safety Instructions, 2
  - Wall Mounting, 5, 6, 30

## O

### OSD

- Adjust Audio Out, 51
- Advanced Image Settings for PC, 50
- Advanced Image Settings for Video Inputs, 49
- Advanced Picture Adjustments, 48
- Aspect Ratio, 50
- Auto Adjustment for PC Input, 50
- Auto Volume, 51
- Balance Adjustment, 51
- Bass Adjustment, 51
- Block unrated movies, 51
- Brightness Adjustment, 48, 49, 63
- Clock for PC Input, 50
- Closed Caption, 52
- Closed Caption Selection, 13, 40
- Color Adjustment, 16, 48
- Color Temp for PC Input, 50
- Contrast Adjustment, 48, 49, 63
- Custom Color Adjustment, 48
- Display Settings, 50
- Dynamic Contrast, 49
- Firmware Version, 52
- Fleshtone, 49
- Image Cleaner, 52
- Image Position for PC Input, 50
- Image Settings for PC, 49
- Image Settings for Video Inputs, 48
- Noise Reduction, 49
- Operations, 47
- Phase for PC Input, 50
- Picture Mode Selection, 48
- PIP, 50
- Return Adjustments to Factory Settings, 52
- Selecting the OSD Language, 52
- Set Parental Control Level for Movies, 51
- Set Parental Control Level for TV Programs, 51
- Sharpness Adjustment, 48
- Surround Sound On or Off, 51
- Tint (Hue) Adjustment, 48
- Treble Adjustment, 51
- Turn the Speakers ON or Off, 51
- Using the Parental Controls, 51, 55
- Outputs
  - Using 5.1 Surround with a Home Theatre System, 28
  - Using an external Receiver/Amp, 28

## P

### Parental Controls



Movie Rating, 56  
TV Rating, 55  
PIP and POP Inputs, 54

## **R**

Remote  
Batteries, 15  
Layout, 12, 15, 57  
Range, 15  
Remote Control  
Codes for other devices., 69  
Programming to work your DVD Player, 58  
Programming to work your Set-Top Box, 57  
Programming to work your VCR, 57  
Using your Cable or Satellite Remote to Operate your VIZIO TV, 58  
RGB  
Connecting your PC, 29

## **S**

Screen Size explanation, 53  
Sticking Image Removal, 52  
S-Video  
Connecting your DVD Player, 20

## **T**

Technical Specifications, 63  
Troubleshooting Guide, 59

## **W**

Warranty, 68  
Watching TV  
Basic connections, 30  
Getting your Programs, 33



## 5.4 Limited Product Warranty

Please read this warranty card carefully, it is a "ONE-YEAR LIMITED WARRANTY" on parts and labor and is only valid when purchased from an Authorized Reseller, only on new and non-refurbished product, and available to customers in the Continental US, Alaska, Hawaii and Puerto Rico. See below for the VIZIO Extended Service warranty.

### VIZIO's Responsibility

VIZIO Displays purchased in the United States are warranted to be free from defects in materials or workmanship for a period of one (1) year from the date of their original retail purchase. If the unit fails to conform to this warranty, we will service the monitor using new or refurbished parts.

### Service Labor

During a period of one (1) year from the effective warranty date, VIZIO will provide, when needed, service labor to repair a manufacturing defect at its designated Service Center. To obtain warranty service in the United States, you must first call our Customer Support at (714) 668-0588, 7:30 am – 5:30 pm PST. The determination of service will be made by VIZIO Customer Support. PLEASE DO NOT RETURN YOUR UNIT TO VIZIO WITHOUT PRIOR AUTHORIZATION.

### Parts

New or remanufactured replacements for defective parts will be used for repairs by VIZIO at its designated Service Center for one (1) year from the effective warranty date. Such replacement parts are warranted for the remaining portion of the original warranty period.

### Service

During the one (1) year warranty period, VIZIO will, at its option and sole discretion, repair or replace defective parts, including replacement of the entire Panel. The Customer will be required to ship the unit to the Service Center indicated at the time Customer Support is contacted to make the necessary repairs, you are responsible for all transportation charges to and from the service facility. VIZIO is not responsible for the de-installation or re-installation of the unit.

### Packaging and Shipping Instruction

When you send the product to an authorized VIZIO service facility you must use the original carton box and packing material or an equivalent as designated by VIZIO

### Not Covered

This warranty does not cover defects, malfunctions or failures resulting from shipping or transit accidents, abuse, misuse, operation contrary to furnished instructions, operation on incorrect power supplies, operation with faulty associated equipment, modification, alteration, improper servicing, tampering or normal wear and tear or TVs on which the serial number has been removed or defaced. Image Sticking caused by operating at excessive brightness levels for extended periods or mishandling are not covered by this warranty.

ANY IMPLIED WARRANTIES, INCLUDING ANY IMPLIED WARRANTY OF MERCHANTABILITY AND FITNESS FOR A PARTICULAR PURPOSE SHALL BE LIMITED IN DURATION TO THE PERIOD OF TIME SET FORTH ABOVE. OUR LIABILITY FOR ANY AND ALL LOSSES AND DAMAGES RESULTING FROM ANY CAUSE WHATSOEVER, INCLUDING OUR NEGLIGENCE, ALLEGED DAMAGE OR DEFECTIVE GOODS, WHETHER SUCH DEFECTS ARE DISCOVERABLE OR LATENT, SHALL IN NO EVENT EXCEED THE PURCHASE PRICE OF THE DISPLAY. WE SHALL NOT BE RESPONSIBLE FOR LOSS OF USE, COMMERCIAL LOSS OR OTHER INCIDENTAL OR CONSEQUENTIAL DAMAGES. SOME STATES DO NOT ALLOW LIMITATIONS ON HOW LONG AN IMPLIED WARRANTY LASTS OR THE EXCLUSION OR LIMITATION OF INCIDENTAL OR CONSEQUENTIAL DAMAGES, SO THE ABOVE LIMITATIONS OR EXCLUSIONS MAY NOT APPLY TO YOU. This warranty gives you specific legal rights, and you may also have other rights which vary from state to state. This is the only warranty applicable; no one is authorized to extend or modify it or to grant any other warranty.

VIZIO retains the right to assess all warranty claims and to determine if damages are covered by the warranty. In case of a claim that is not covered by the warranty, you will be contacted to determine whether VIZIO should repair the damage for a fee or whether the product should be returned to you as received by the repair center.

### Owner's Responsibility

Effective Warranty Date

Warranty begins on the date of sale to the end user. To ensure warranty service, keep the dated bill or sale receipt as evidence of the purchase date.

### Warranty Service

For warranty service information, contact VIZIO Customer Support at (714) 668-0588 or visit [www.vizioce.com](http://www.vizioce.com). Parts and service labor that are VIZIO's responsibility (see above) will be provided without charge. Other service is at the owner's expense. You must provide the model, serial number and date of purchase. Before you ask for warranty service, read your User Manual. You might avoid a service call.

Warranty conditions are subject to change, for latest Warranty Terms and Conditions and additional information regarding your warranty, please see complete details online at [www.VIZIOCE.com](http://www.VIZIOCE.com).

## 5.4.1 VIZIO EXTENDED SERVICE WARRANTY

Protect your investment beyond the standard warranty and experience piece of mind with VIZIO's Extended Service Warranty.

Depending on your model, plans are offered for 2-5 years. Visit [www.vizioce.com](http://www.vizioce.com) or call 1-800-988-4196 to purchase a plan today.



## 5.5 Component Program Codes

Setup Code for VCR's		Setup Code for VCR's		Setup Code for VCR's	
ABS	21972	Emerson	20035, 20037, 20184, 20240, 20045, 20121, 20043, 20209, 20002, 20278, 20479	Marantz	20035, 20081
Admiral	20048, 20209	Fisher	20047, 20104	Marta	20037
Aiko	20278	Fuji	20035, 20033	Matsushita	20035, 20162
Aiwa	20037, 20479	Fujitsu	20045	Media Center PC	21972
Alienware	21972	Gateway	21972	MEI	20035
America Action	20278	GE	20060, 20035, 20240	Memorex	20035, 20162, 20037, 20048, 20039, 20047, 20240, 20104, 20209, 20479
American High	20035	General	20045	MGA	20240, 20043
Amoisonic	20479	Go Video	20432	MGN Technology	20240
Anam	20162, 20037, 20240, 20278	GoldStar	20037, 20209, 20038, 20225	Microsoft	21972
Anam National	20162	Haojie	20240	Mind	21972
Asha	20240	Harman/Kardon	20081, 20038	Minolta	20042
Audiovox	20037, 20278	Harwood	20072	Mitsubishi	20067, 20043
Beaumark	20240	Hewlett Packard	21972	Motorola	20035, 20048
Bell & Howell	20104	HI-Q	20047	MTC	20240
Broksonic	20184, 20121, 20209, 20002, 20479	Hitachi	20037, 20042, 20055	Multitech	20072
Calix	20037	Howard Computers	21972	NEC	20035, 20037, 20048, 20104, 20067, 20038
Canon	20035	HP	21972	Newave	20037
Carver	20081	Hughes Network Systems	20042, 20739	Nikko	20037
CCE	20072, 20278	iBUYPOWER	21972	Noblex	20240
Changhong	20048, 20081	JVC	20045, 20067	Northgate	21972
Citizen	20037, 20278	KEC	20037, 20278	Olympus	20035
Colt	20072	Kenwood	20067, 20038	Optimus	21062, 20162, 20037, 20048, 20104, 20432
Craig	20037, 20047, 20240, 20072	KLH	20072	Orion	20184, 20209, 20002, 20479
Curtis Mathes	20060, 20035, 20162	Kodak	20035, 20037	Panasonic	21062, 20035, 20162, 20616, 20225
Cybernex	20240	Kolin	20043	Penney	20035, 20037, 20240, 20042, 20038
CyberPower	21972	LG	20037, 20045, 20042, 20209, 20038	Pentax	20042
Daewoo	20045, 20104, 20278	Logik	20072	Philco	20035, 20479
Dell	21972	LXI	20037	Philips	20035, 20081, 20739, 20618
Denon	20042	Magnavox	20035, 20039, 20081	Pilot	20037
DirectTV	20739	Magnin	20240		
Durabrand	20039, 20038				
Electrohome	20037				
Electrophonic	20037				
Emerex	20032				



Setup Code for VCR's	
Pioneer	20042, 20067
Polk Audio	20081
Profitronic	20240
Proscan	20060
Protec	20072
Pulsar	20039
Qisheng	20060
Quasar	20035, 20162
Radix	20037
Randex	20037
RCA	20060, 20035, 20240, 20042, 20880
Realistic	20035, 20037, 20048, 20047, 20104
ReplayTV	20616
Runco	20039
Sampo	20037, 20048
Samsung	20240, 20045, 20432
Sanky	20048, 20039
Sansui	20067, 20209, 20479
Sanyo	20047, 20240, 20104
Scott	20184, 20045, 20121, 20043
Sears	20035, 20037, 20047, 20042, 20104
Sharp	20048, 20209
Shintom	20072
Shogun	20240
Singer	20072
Sonic Blue	20616
Sony	20035, 20032, 20033, 20636, 21972
STS	20042
Sylvania	20035, 20081, 20043
Systemax	21972
Tagar Systems	21972
Tashiko	20037

Setup Code for VCR's	
Tatung	20045, 20067
Technics	20035, 20162
Teco	20035, 20037, 20048, 20038
Teknika	20035, 20037
Tivo	20636, 20618, 21503, 20739
TMK	20240
Toshiba	20045, 20042, 20067, 20043, 21503, 21008, 21972
Totevision	20037, 20240
Touch	21972
Unitech	20240
Vector	20045
Vector Research	20038
Victor	20067
Video Concepts	20045
Videomagic	20037
Videosonic	20240
Viewsonic	21972
Wards	20060, 20035, 20048, 20047, 20081, 20240, 20042, 20072
White Westinghouse	20209, 20072
XR-1000	20035, 20072
Yamaha	20038
Zenith	20039, 20033, 20209, 20479
ZT Group	21972

Setup Code for Cable Converters	
ABC	00003, 00008, 00014
Americast	00899
Bell & Howell	00014
Bell South	00899
Clearmaster	00883
ClearMax	00883
Coolmax	00883
Daeryung	01877, 00877,

Setup Code for Cable Converters	
	00477, 00008
Digi	00637
Director	00476
Dumont	00637
Gehua	00476
General Instrument	00476, 00810, 00276, 00003, 00014
GoldStar	00144
Hamlin	00009, 00273
Hitachi	00014
Jerrold	00476, 00810, 00276, 00003, 00012, 00014
KNC	00008
LG	00144
Memorex	00000
Motorola	00476, 00810, 00276, 01254, 01376
MultiVision	00012
Pace	01877, 00237
Panasonic	00000, 00008, 00107
Panther	00637
Paragon	00000
Philips	00317, 01305
Pioneer	01877, 00877, 00144, 00533
Pulsar	00000
Quasar	00000
RadioShack	00883
Regal	00279, 00273
Runco	00000
Samsung	00000, 00144
Scientific Atlanta	01877, 00877, 00477, 00008
Sony	01006
Starcom	00003, 00014
Supercable	00276
Supermax	00883
Tocom	00012
Torx	00003



Setup Code for Cable Converters	
Toshiba	00000
Trans PX	00276
Tristar	00883
TS	00003
V2	00883
Viewmaster	00883
Vision	00883
Vortex View	00883
Zenith	00000, 00525, 00899

Setup Code for Satellite Receivers	
AlphaStar	00772
Chaparral	00216
Crossdigital	01109
DirecTV	00392, 00566, 00639, 01142, 00247, 00749, 01749, 00724, 00819, 01856, 01076, 01109, 00099, 01392, 01640, 01442, 01414, 01108
Dish Network System	01005, 00775, 01505
Dishpro	01005, 00775, 01505
Echostar	01005, 00775, 01505
Expressvu	00775
GE	00566
General Instrument	00869
GOI	00775
Goodmans	01246
Hisense	01535
Hitachi	00819, 00222, 01250
HTS	00775
Hughes Network Systems	01142, 00749, 01749, 01442
I-Lo	01535
JVC	00775

Setup Code for Satellite Receivers	
LG	01414, 01226
Magnavox	00724, 00722
Memorex	00724
Mitsubishi	00749
Motorola	00869
NEC	01270
Next Level	00869
Panasonic	00247, 00701
Paysat	00724
Philips	01142, 00749, 01749, 00724, 01076, 00722, 00099, 01442
Proscan	00392, 00566
Proton	01535
RadioShack	00869
RCA	00392, 00566, 00855, 00143, 01392
Samsung	01276, 01109, 01108
Sanyo	01219
SKY	00856
Sony	00639, 01640
Star Choice	00869
Tivo	01142, 01442
Toshiba	00749, 01749, 00790, 01285
UltimateTV	01640, 01392
Uniden	00724, 00722
US Digital	01535
USDTV	01535
Voom	00869
Zenith	00856, 01856

Setup Code for Digital Video Disks	
Aiwa	20641, 21912
Akai	20770
Allegro	20869
Apex Digital	20672, 20717, 20797, 21061, 20796, 21056,

Setup Code for Digital Video Disks	
	21937, 20794, 21020, 21915
Blaupunkt	20717
Blue Parade	20571
Broksonic	20695
Changhong	20627, 21061
CineVision	20869
Coby	21086
Curtis Mathes	21087
CyberHome	21024, 21023, 21129, 20816, 21117
Daewoo	20833, 21172, 20869
Denon	20490
DVD2000	20521
Emerson	20591, 20675
Enterprise	20591
Fisher	21919
Funai	20675
Gateway	21158, 21073
GE	20522, 20717
Go Video	20744, 20833, 21099, 20783, 21075, 20869, 21730
Greenhill	20717
Harman/Kardon	20582, 20702
Hitachi	20573, 20664, 21919
Hiteker	20672
Initial	20717
Integra	20627, 21924
JBL	20702
JVC	20558, 20623, 20867
Kenwood	20490, 20534
KLH	20717, 21020, 21149
Koss	20651, 21980
Lasonic	20798
LG	20591, 20869, 20801
Liquid Video	21980



Setup Code for Digital Video Disks	
Lite-On	21158, 21058
Loewe	20511
Magnavox	20503, 20539, 21976, 21914, 20675
Marantz	20539
Memorex	20695
Microsoft	20522
Mintek	20717
Mitsubishi	21521, 20521
Nesa	20717
Norcent	21003
Onkyo	20503, 20627, 21924, 20792
Oritron	20651, 21980
Panasonic	20490, 21762, 21990
Philips	20503, 20539, 20646, 21914
Pioneer	20525, 20571
Polaroid	21086, 21061
Polk Audio	20539
Portland	20770
Proscan	20522
Qwestar	20651
RCA	20522, 20571, 20717, 20822
Rio	20869
Rotel	20623
Sampo	20752, 20698
Samsung	20490, 20573, 21932, 21075, 20820
Sansui	20695
Sanyo	20695
Sharp	20630, 20752
Sharper Image	21117
Sherwood	20770
Shinco	20717
Shinsonic	20533
Sonic Blue	20869, 21099
Sony	20533, 20864, 21033, 21904,

Setup Code for Digital Video Disks	
	21903
SVA	20717
Sylvania	20675
Symphonic	20675
Teac	20717, 21984, 20809
Technics	20490
Theta Digital	20571
Toshiba	20503, 20695
Urban Concepts	20503
<b>V, Inc.</b>	<b>20123, 20124</b>
Xbox	20522
Yamaha	20490, 20539, 20545
Zenith	20503, 20591, 20869

Setup Code for CD Players	
Aiwa	30157
Burmester	30420
California Audio Labs	30029
Carver	30157, 30179
Denon	30873
DKK	30000
DMX Electronics	30157
Dynamic Bass	30179
Fisher	30179
Garrard	30420
Genexxa	30032
Harman/Kardon	30157, 30173
Hitachi	30032
Integra	30101
JVC	30072
Kenwood	30826, 30626, 30028, 30037, 30036, 30190
Krell	30157
Linn	30157
Magnavox	30157
Marantz	30626, 30029, 30157

Setup Code for CD Players	
MCS	30029
Miro	30000
Mission	30157
MTC	30420
NSM	30157
Onkyo	30868, 30101
Optimus	31063, 30000, 30032, 30037, 30420, 30179, 31075, 30145
Panasonic	30029
Parasound	30420
Philips	30626, 30157
Pioneer	31063, 31062, 30032
Polk Audio	30157
Proton	30157
QED	30157
Quad	30157
Quasar	30029
RadioShack	31075
RCA	31062, 30032, 30420, 30179, 30053
Realistic	30420, 30179
Rotel	30157, 30420
SAE	30157
Sansui	30157
Sanyo	30179
SAST	30157
Sharp	30861, 30037
Silsonic	30888, 30036
Sonic Frontiers	30157
Sony	30490, 30000, 30100
Soundesign	30145
TAG McLaren	30157
Tascam	30420
Teac	30420
Technics	30029
Victor	30072
Wards	30157, 30053





Setup Code for CD Players	
Yamaha	30888, 30036
Zonda	30157

Setup Code for Audio Amplifiers	
Bose	30674
GE	30078
JVC	30331
Marantz	30321
Nakamichi	30321
NEC	30264
Optimus	30395
Realistic	30395
Sansui	30321
Shure	30264
Sony	30689
Soundesign	30078
Victor	30331
Wards	30078
Yamaha	30354, 30133

Setup Code for Audio Amp/Tuners	
ADC	30531
Aiwa	31405, 31243, 30121
Anam	31609, 31074
Audiotronic	31189
Bose	31229
Capetronic	30531
Carver	31189
Coby	31263
Denon	31360, 31142, 30904
Fonmix	31360
Glory Horse	31263
Harman/Kardon	30110
Hitachi	31273
Inkel	30027
Integra	30135

Setup Code for Audio Amp/Tuners	
JBL	30110
JVC	30074, 31263
Kenwood	31313, 31570, 30027
KLH	31428
Magnavox	31189, 31269, 30531
Marantz	31189, 31269, 30039
MCS	30039
Onkyo	30842, 30135
Optimus	31023, 30670, 30531, 31074
Panasonic	31518, 30039
Philips	31189, 31269
Pioneer	31023, 30150, 30014, 30630, 30531
Proscan	31254
Qisheng	31609
Quasar	30039
RadioShack	31263
RCA	31023, 31609, 31254, 30531, 31074
Sharper Image	31263
Silsonic	30176
Sony	31058, 31441, 31258, 31759
Soundesign	30670
Stereophonics	31023
Sunfire	31313
Teac	31074, 31267
Technics	31308, 31518, 30039
Thorens	31189
Victor	30074
Wards	30014
Yamaha	30176, 31276, 31176

Setup Code for TV's	
Addison	10092

Setup Code for TV's	
Admiral	10093, 10463
Advent	10761, 10842
Aiko	10092
Aiwa	11914
Akai	10812, 10702, 10030, 10672, 11903
Albatron	10700, 10843
America Action	10180
Anam	10250, 10180, 10700
Anam National	10250, 10650
Anhua	10051
AOC	10451, 10093, 10180, 10060, 10030, 10178, 10092
Apex Digital	10748, 10765, 10879, 10767, 11943
Audiovox	10451, 10180, 10875, 10092, 10623
Baile	10661
Beijing	10812, 10661
Bell & Howell	10154
BenQ	11032
Bradford	10180
Broksonic	10236, 10463, 11911, 11938, 11905, 11935, 11929
Cailing	10748
Candle	10030
Carnivale	10030
Carver	10054
Celebrity	10000
Celera	10765
Changcheng	10051, 10661
Changhong	10156, 10765, 11156, 10767
Ching Tai	10092
Chun Yun	10000, 10180, 10700, 10092, 10843
Chung Hsin	10180, 10053



Setup Code for TV's	
Cinema	10672
Citizen	10060, 10030, 11928, 10092
Clarion	10180
Commercial Solutions	11447, 10047
Conrowa	10156, 10145, 11156
Contec	10180
Craig	10180
Crosley	10054
Crown	10180
Curtis Mathes	10047, 10054, 10154, 10451, 10093, 10060, 10702, 10030, 10145, 10166
CXC	10180
Daewoo	10154, 10451, 10180, 10030, 10178, 10672, 11928, 10092, 10661, 11909, 10623, 10700
Dayu	10661
Dell	11080
Denon	10145
Dumont	10017
Durabrand	10463, 10180, 10178, 10171, 11034
Electroband	10000
Emerson	10154, 10236, 10463, 10180, 10178, 10171, 11944, 11909, 11929, 11905, 11928, 10623, 11911
Envision	10030
Ether	10030
Firststar	10236
Fisher	10154
Fortress	10093
Fujitsu	10809, 10853
Funai	10180, 10171, 11904
Furi	10145

Setup Code for TV's	
Futuretech	10180
Gateway	11756, 11755
GE	11447, 10047, 11454, 10051, 10451, 10180, 10030, 10178, 11917, 10092, 11907, 11922
Gibraltar	10017, 10030
GoldStar	10154, 10030, 10178, 11926
Grunpy	10180
Haier	11034
Hallmark	10178
Hankook	10180, 10030, 10178
Harley Davidson	11904
Harman/Kardon	10054
Harvard	10180
Havermy	10093
Helios	10865
Hello Kitty	10451
Hisense	10156, 10748, 10145, 11156
Hitachi	10156, 10030, 10178, 11145, 10145, 10092, 11904, 11156
Hongmei	10093
Huafa	10145
Huari	10145
Huodateji	10051
Imperial Crown	10661
Infinity	10054
Inteq	10017
JBL	10054
JCB	10000
Jean	10156, 10051, 10236, 10092
Jensen	10761
Jiahua	10051
Jinfeng	10051
Jinxing	10054, 10156, 10145
JVC	10053, 11923,

Setup Code for TV's	
	11253
Kangli	10661
KEC	10180
Kenwood	10030
KLH	10765, 10767
Kolin	10180, 10150, 10053
KTV	10180, 10030
Kunlun	10051, 10661
LG	10060, 10030, 10178, 10856, 10700, 10025
Lloyd's	11904
LXI	10047, 10054, 10154, 10156, 10178
Magnasonic	11928, 11913
Magnavox	11454, 10054, 10030, 10706, 11931, 11254, 11913, 11904, 11944
Magnin	11907
Marantz	10054, 10030, 10704
Matsushita	10250, 10650
Maxent	11755
Megapower	10700
Megatron	10178, 10145
Memorex	10154, 10463, 10150, 10178, 11911, 11926, 11924, 11920, 11927
MGA	10150, 10030, 10178, 11907
Midland	10047, 10017, 10051
Mitsubishi	10154, 10250, 10093, 10236, 10180, 11250, 10150, 10030, 10178, 11917, 10836
Monivision	10843, 10700
Motorola	10093
MTC	10060, 10030
Mudan	10051



Setup Code for TV's	
Multitech	10180
NAD	10156, 10178, 10866
National	10051
NEC	10154, 10156, 10051, 10053, 10030, 10178, 11704
Newave	10093, 10178, 10092
Nikko	10030, 10178, 10092
Norcent	10748, 10824
NTC	10092
Onwa	10180
Optimus	10154, 10250, 10166, 10650, 11927, 11924, 11913
Optonica	10093
Orion	10236, 10463, 11929, 11911, 11905
Panasonic	10054, 10250, 10051, 10650, 11941, 11927, 11924
Panda	10051, 10706
Penney	10047, 10156, 10051, 10060, 10030, 10178, 11926, 11907
Philco	10054, 10180, 10030, 10178
Philips	11454, 10054, 10000, 10051, 10030, 10178, 10092, 10690
Pilot	10030
Pioneer	10166, 10866, 10679
Portland	10092
Prima	10761
Princeton	10700
Prism	10051
Proscan	11447, 10047, 11922
Proton	10030, 10178
Pulsar	10017

Setup Code for TV's	
Qingdao	
Quasar	10250, 10051, 11924, 10650
RadioShack	10047, 10154, 10180, 10030, 10178, 11920, 11904
RCA	11447, 10047, 11454, 10000, 10030, 10178, 11547, 11922, 11917, 10092, 11907, 11948, 10090, 10679
Realistic	10154, 10180, 10030, 10178
Rowa	10748
Runco	10017, 10030
Sampo	10154, 10093, 10030, 10178, 10171, 10700, 10650, 11755, 10092
Samsung	10154, 10156, 10060, 10812, 10702, 10030, 10178, 11060, 10814, 10092, 11903, 10090, 10766
Sansui	10463, 11904, 11935, 11929, 11911
Sanyo	10154, 10156, 10180, 10145, 11907
Sanyuan	10093
Scotch	10178
Scott	10236, 10180, 10178
Sears	10047, 10054, 10154, 10156, 10178, 10171, 11926, 11904
Shaofeng	10145
Sharp	10093, 10030, 10650, 11917
Shen Ying	10092
Shencai	10145
Sheng Chia	10093, 10236
Skygiant	10180
Skyworth	10748

Setup Code for TV's	
Sony	11100, 10000, 10650, 11925, 11904
Soundesign	10180, 10178
Sowa	10156, 10051, 10060, 10178, 10092
Squareview	10171
SSS	10180
Starlite	10180
Studio Experience	10843
Supreme	10000
SVA	10748, 10865
Sylvania	10054, 10030, 10171, 11944, 11931
Symphonic	10180, 10171, 11913, 11904
Synco	10000, 10451, 10093, 10060, 10178, 10092
Tacico	10178, 10092
Tandy	10093
Tashiko	10092, 10650
Tatung	10054, 10154, 10156, 10051, 10060, 11156, 11756, 11254
Technics	10250, 10051
Techwood	10051
Teco	10051, 10093, 10178, 10092
Teknika	10054, 10180, 10150, 10060, 10092
Telefunken	10702
Tera	10030
Thomas	11904
Tiane	10093
TMK	10178
TNCi	10017
Tobo	10748
Toshiba	10154, 10156, 10060, 10145, 11945, 11704, 11936, 11156, 11935, 10650, 11918



Setup Code for TV's	
Tuntex	10030, 10092
TVS	10463
<b>VIZIO</b>	<b>11758, 11756, 10885, 10864</b>
Vector Research	10030
Victor	10250, 10053, 10650
Vidikron	10054

Setup Code for TV's	
Vidtech	10178
Viewsonic	11755, 10885, 10864
Wards	10054, 10030, 10178, 10866, 11156
Warumaia	10661
Waycon	10156

Setup Code for TV's	
White Westinghouse	10463, 11909, 10623
Yamaha	10030
Yapshe	10250
Zenith	10017, 10463, 10178, 11904, 11929, 11911, 11909, 10092

